



# Bobcat®

COMPACT EXCAVATORS

E34 E35z



*One Tough Animal®*

# MAXIMUM PERFORMANCE AND COMFORT IN COMPACT FORMAT

The new Bobcat E34 and E35z are built around the operator - providing a roomy and comfortable cab, with great visibility. Easy to operate, these machines are amazingly stable and provide performance and transportability.

These compact machines offer a mix of traditional Bobcat performance and best-in-class controllability. And, so that you can keep working without interruption, their design and manufacture use the latest technology for guaranteed reliability.



## **E34 - Conventional Tail Swing**

- Machine is just 1550 mm wide
- Ideal for highly demanding applications where performance must be combined with compactness

## **E35z - Zero House Swing (ZHS)**

- Zero House Swing concept for peace of mind
- Best possible mix of compactness, a large operating range and great stability

# RESPECTED PERFORMANCE WITH ENHANCED CONTROLLABILITY



## A new generation

The new generation of 3.5 ton Bobcat excavators offers higher stability coupled with excellent performance and even greater controllability.

## Zero House Swing (ZHS) concept for E35z

The Bobcat Zero House Swing (ZHS) concept enhances Zero Tail Swing (ZTS) functionality by further protecting the front upper structure corners when turning within the swing circle. The design of Bobcat machines also eliminates the 'unicorn' effect of having the boom swing cylinder exposed during parallel digging.

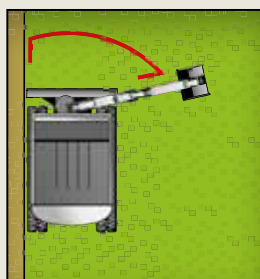

Conventional models

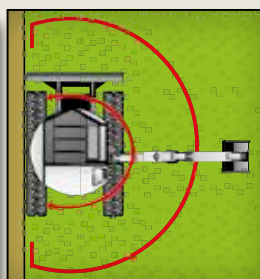

ZHS models

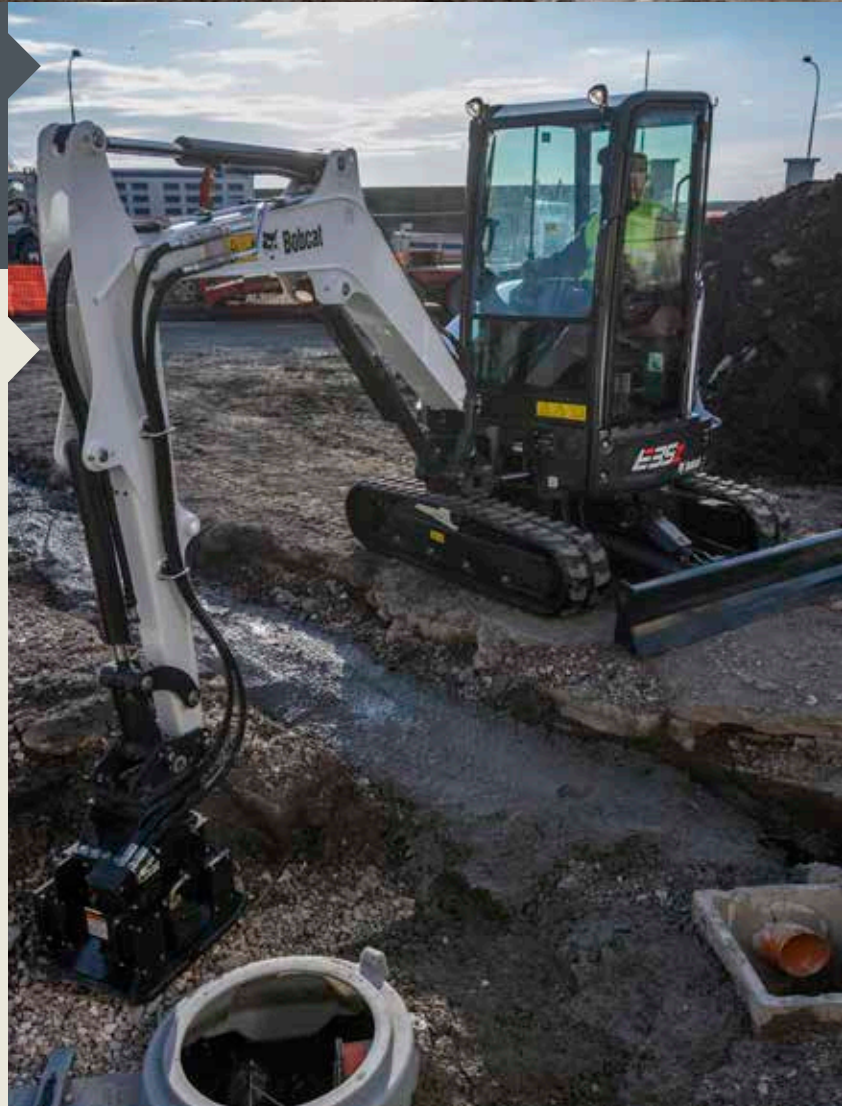

# NO COMPROMISE ON COMFORT

## Great features for extra comfort

Bobcat's spacious and fully featured cabs are legendary, and the Bobcat E34 - E35z cab is no exception.

Thanks to a number of features - like the new engine, air intake, cooling and exhaust systems - you experience less vibration, heat and noise in the E34 and E35z.

And our cab design gives you more space, visibility and overall comfort - so the operator can work without getting tired.



1 - Standard display



1 - Deluxe display

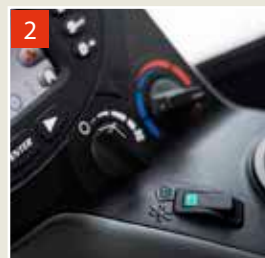

2

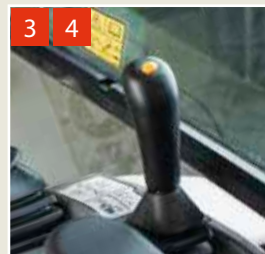

3

4



5

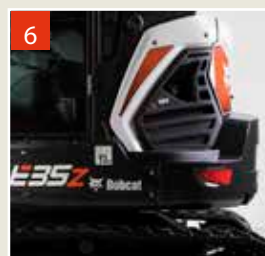

6

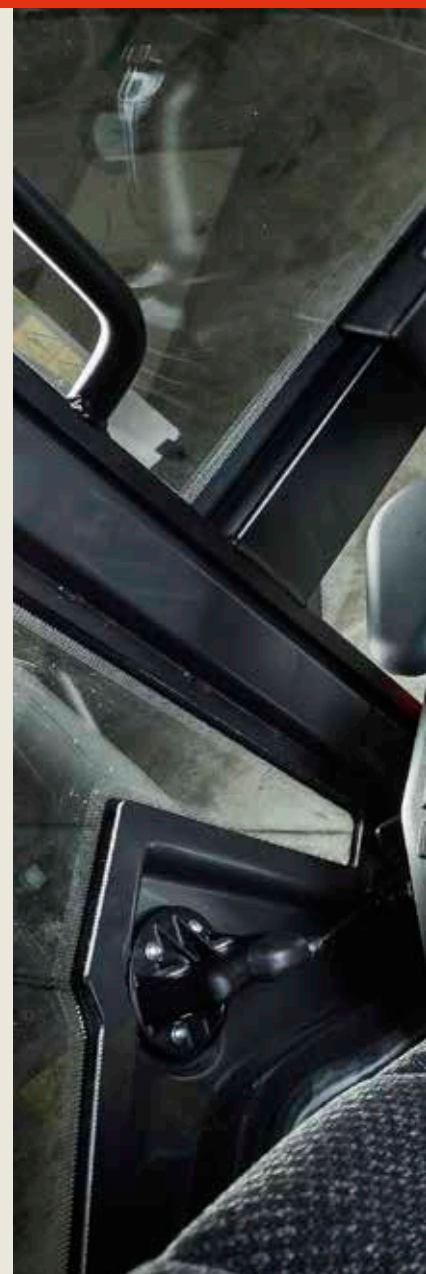

### 1. Instrument panel

The display is clear and easy to reach. It features an indicator for the automatic light switch-off function, optional keyless ignition and operational information such as hours, rpm and job clock.

### 2. Air conditioning

The Bobcat advanced climate control system keeps you comfortable even in extreme weather conditions. The heat and air-conditioning vents allow you to direct airflow where you need it most.

### 3. Second speed, auto-shift and auto-idle

The travel motors automatically return to high speed after downshifting under load. This allows smoother turns and easier dozing work. Auto-idle is available as an option to reduce fuel consumption.

### 4. Floating blade

Automatically controlled blade flotation for quick and easy performance of levelling operations.

### 5. Thumb control for boom swing and auxiliary hydraulics

A thumb control is integrated in the joystick for better metering of the boom swing and the proportional auxiliary hydraulics.

### 6. External fuel cap

The external lockable fuel cap makes refuelling easy and safe. For extra convenience, a warning beep sounds when the maximum fuel level has been reached.

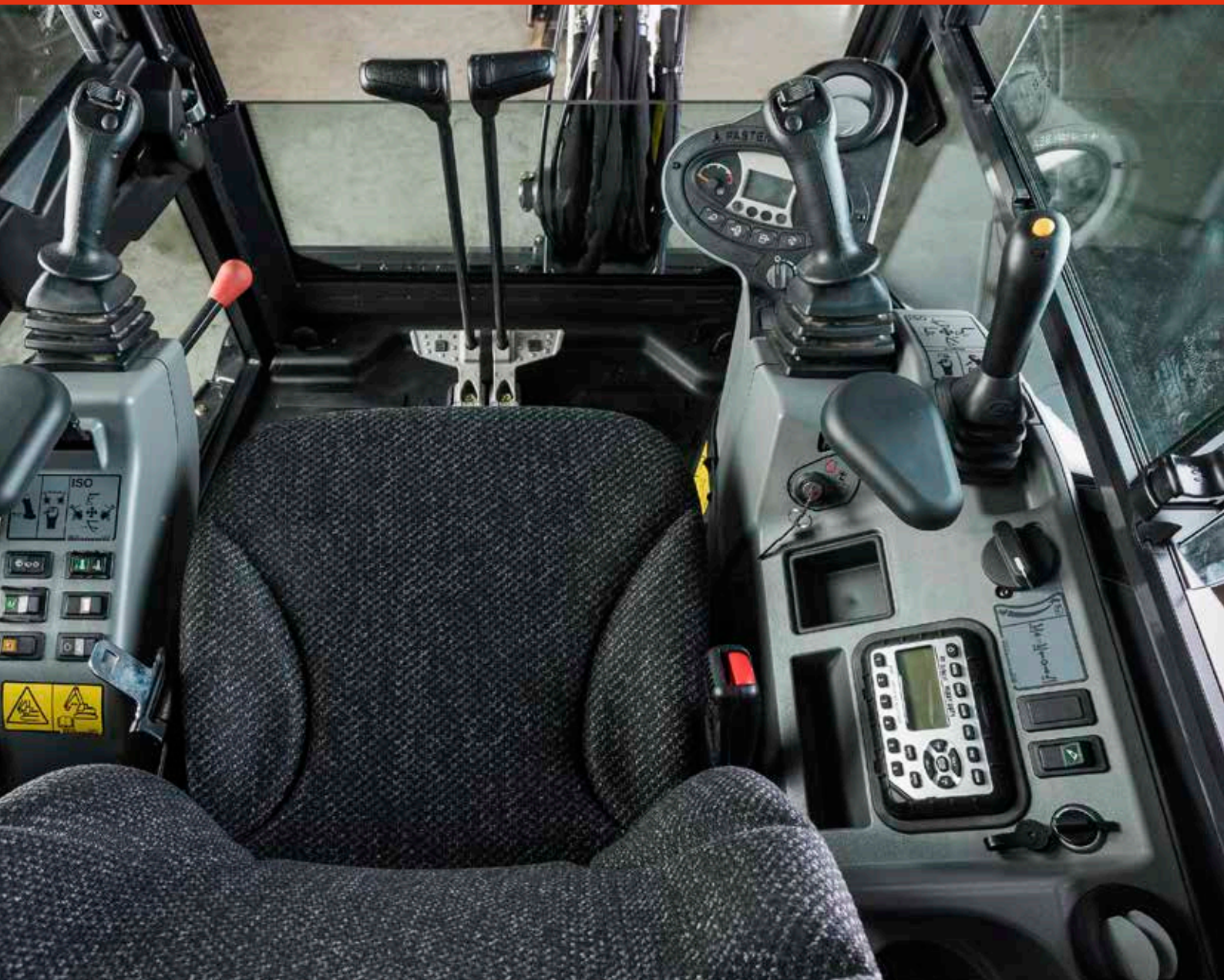

# RENOWNED QUALITY AND EASY MAINTENANCE

## Designed and tested for life-long performance

The materials, components and structures have been stringently tested for endurance under extreme conditions.

## Reliability built into every feature

- Rear tailgates protected by casted counterweights
- Combination of metal covers with weather and impact resistant polymer plastic covers can be opened or bolted on
- New robust protection for boom cylinder
- Proven boom and dipperstick design
- Blade design enhances robustness and self-cleaning
- Increased protection for hoses and pipes
- Wrenchless hydraulic hose technology helps prevent leakage
- 2-piece blade cylinder hoses
- Maintenance-free track rollers and idler
- Auto-tensioning and maintenance-free fan and alternator
- Battery disconnect for storage and transport
- Enhanced level of Fit & Finish for exterior covers, cab & canopy, workgroup
- Paint quality meets highest customer expectations



## Quick and easy servicing

The unrivaled design, quality and durability of Bobcat Genuine Parts ensure minimum downtime and keep your machines performing optimally.

# E34 E35z — SPECIFICATIONS

	E34	E35z
--	-----	------

## WEIGHTS

Operating weight with cab and bucket (ISO 6016)	3476 kg	3499 kg
Transport mass (no attachment)	3312 kg	3335 kg
Weight reduction with canopy	-118 kg	
Additional weight for cab with HVAC	19 kg	
Additional weight for steel tracks	96 kg	
Additional weight for long arm	12 kg	
Additional weight for heavy counterweight	291 kg	

## ENGINE

Make / Model	Kubota / D1703-M-D1-E4B-BC-2
Fuel / Cooling	Diesel / Liquid, forced circulation
Number of cylinders	3
Displacement	1642 cm <sup>3</sup>
Maximum power @ 2200 rpm (ISO 14396)	18.2 kW
Maximum torque (SAE)	97.4 Nm

## PERFORMANCE

Digging force, standard arm (ISO 6015)	20790 N
Digging force, long arm (ISO 6015)	18010 N
Digging force, bucket (ISO 6015)	33430 N
Drawbar pull	34132 N
Travel speed, low range	2.6 km/h
Travel speed, high range	4.7 km/h

## HYDRAULIC SYSTEM

Pump type	Single outlet variable displacement, load sensing torque limited pump with gear pumps
Total hydraulic capacity	101.2 l/min
Auxiliary flow	63.9 l/min
Auxiliary relief	206 bar

## SLEW SYSTEM

Boom swing, left	75°
Boom swing, right	55°
Slew rate	8.6 RPM

## FLUID CAPACITIES

Cooling system	8.0 l
Engine lubrication plus oil filter	5.2 l
Fuel reservoir	52 l
Hydraulic reservoir	8.3 l
Hydraulic system	39.7 l

## ENVIRONMENTAL

Noise level LpA/EU Directive 2006/42/EC	77 dB(A)
Noise level LWA/EU Directive 2000/14/EC	94 dB(A)
Whole body vibration (ISO 2631-1)	0.11 ms <sup>-2</sup>
Hand-arm vibration (ISO 5349-1)	0.34 ms <sup>-2</sup>

## STANDARD FEATURES

1550 mm dozer blade (E34)	Horn	Retractable seat belt
1750 mm dozer blade (E35z)	Hydraulic joystick controls	Suspension seat with high back
300 mm rubber tracks	Proportional fingertip auxiliary and boom swing offset hydraulic control	TOPS/ROPS/FOPS canopy*1
Adjustable double acting auxiliary hydraulic (AUX1) with Quick Couplers	Control console locks	Two-speed travel with Auto shift
Battery disconnect	Cupholder	Upper structure four-point tie down
Blade float feature	Engine/hydraulic monitor with shutdown	Warranty: 12 months, 2000 hours (whichever occurs first)
Clamp ready	Foldable and ergonomic pedals	Water separator
Full fuel warning alarm		Work light (boom)

## OPTIONS

1st AUX hydraulic on arm	Direct-to-tank-AUX1 line	MS03 coupler
2nd AUX hydraulics (boom, arm)	Dlx textile suspension seat	Object handling device (safety valves + overload warning device + lifteye)
Air conditioning (Cab with HVAC)	Fire extinguisher	Special applications kit
AM/FM MP3 stereo radio	Heavy counterweight	Steel tracks
Additional lights (2+1)	Keyless ignition	TOPS/ROPS/FOPS cab with heater
Auto idle	Klac coupler	Travel motion alarm
Beacon	LED lights set	
Bobcat hydr. pin grabber	Left and right mirror	
	Long arm	

## WORKING RANGE

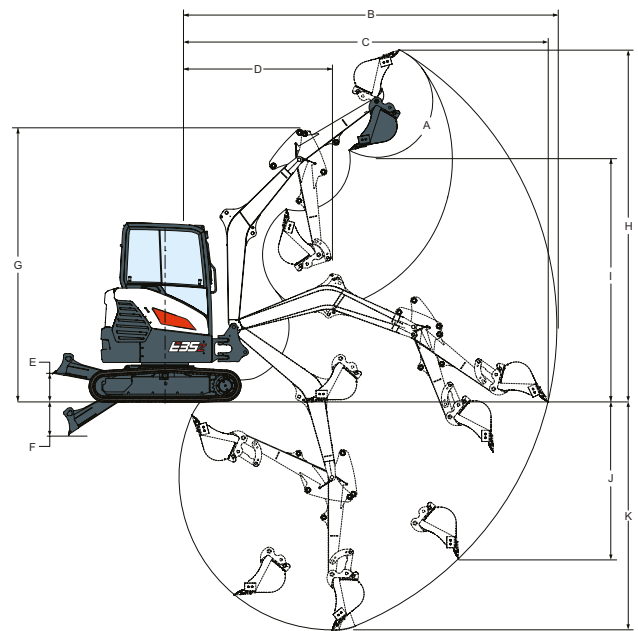

	A	B	B*	C	C*	D	D*	E	F
E34	185°	5101	5383	4980	5270	2017	2077	382	456
E35z	185°	5351	5633	5230	5520	2267	2324	382	456

	G	G*	H	H*	I	I*	J	J*	K	K*
E34	3708	3708	4804	4985	3340	3521	2136	2414	3117	3417
E35z	3708	3708	4804	4985	3340	3521	2136	2414	3117	3417

## DIMENSIONS

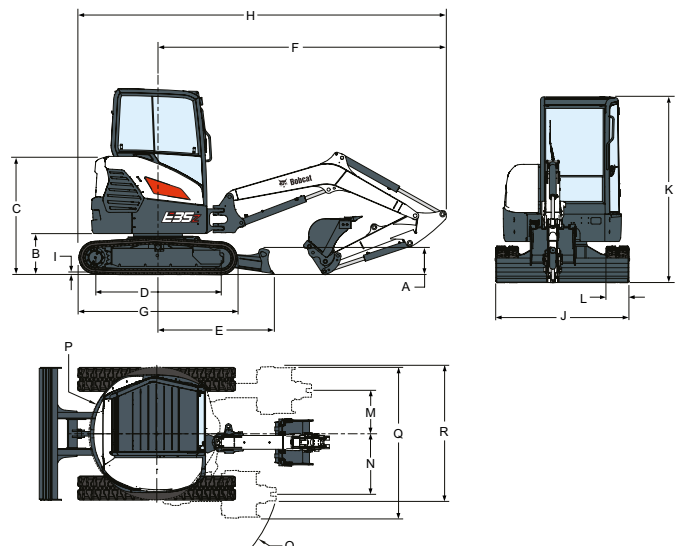

	A	B	C	D	E	F	F*	G	H	H*	I
E34	322	540	1557	1542	1528	3787	3796	1970	4661	4761	25
E35z	322	540	1557	1647	1528	3787	3796	2074	4823	4832	25

	J	K	L	M	N	O	O*	P	P*	Q	R
E34	1550	2468	300	371	554	1623	1678	1125	1215	1982	1855
E35z	1750	2468	300	575	795	1788	1841	875	965**	1841	1805

\* with long arm \*\* with heavy counterweight

\*1 Roll Over Protective Structure (ROPS) – Meets requirements of ISO 3471. Tip Over Protective Structure (TOPS) – Meets requirements of ISO 12117. Falling Object Protective Structure (FOPS) – Meets requirements of ISO 3449.

# E34 E35z — LIFTING CAPACITIES

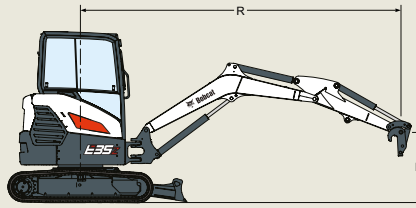

RATED LIFT CAPACITY - OVER BLADE / BLADE DOWN						RATED LIFT CAPACITY - OVER SIDE / BLADE UP				
E34 - STANDARD ARM, STANDARD COUNTERWEIGHT										
Lift Point Height [H]	Max. radius [R] (mm)	Lift at max. radius (kg)	Lift radius [R] (kg)			Max. radius [R] (mm)	Lift at max. radius (kg)	Lift radius [R] (kg)		
			2000 mm	3000 mm	4000 mm			2000 mm	3000 mm	4000 mm
4000 mm	2690	565*	-	-	-	2690	332	-	-	-
3000 mm	3680	716*	-	-	-	3680	385	-	-	-
2000 mm	4180	764*	-	819*	757*	4180	319	-	517	339
1000 mm	4300	842*	-	1111*	857*	4300	299	-	498	332
Ground	4150	872*	2193*	1303*	930*	4150	310	843	491	327
-1000 mm	3740	959*	1987*	1273*	-	3740	362	842	490	-

RATED LIFT CAPACITY - OVER BLADE / BLADE DOWN						RATED LIFT CAPACITY - OVER SIDE / BLADE UP				
E34 - STANDARD ARM, HEAVY COUNTERWEIGHT										
Lift Point Height [H]	Max. radius [R] (mm)	Lift at max. radius (kg)	Lift radius [R] (kg)			Max. radius [R] (mm)	Lift at max. radius (kg)	Lift radius [R] (kg)		
			2000 mm	3000 mm	4000 mm			2000 mm	3000 mm	4000 mm
4000 mm	2690	565*	-	-	-	2690	543	-	-	-
3000 mm	3680	716*	-	-	-	3680	507	-	-	-
2000 mm	4180	764*	-	819*	757*	4180	424	-	675	450
1000 mm	4300	842*	-	1111*	857*	4300	401	-	656	442
Ground	4150	872*	2193*	1303*	930*	4150	416	1117	649	438
-1000 mm	3740	959*	1987*	1273*	-	3740	482	1116	648	-

RATED LIFT CAPACITY - OVER BLADE / BLADE DOWN						RATED LIFT CAPACITY - OVER SIDE / BLADE UP				
E34 - LONG ARM, HEAVY COUNTERWEIGHT										
Lift Point Height [H]	Max. radius [R] (mm)	Lift at max. radius (kg)	Lift radius [R] (kg)			Max. radius [R] (mm)	Lift at max. radius (kg)	Lift radius [R] (kg)		
			2000 mm	3000 mm	4000 mm			2000 mm	3000 mm	4000 mm
4000 mm	3210	664*	-	-	-	3210	664*	-	-	-
3000 mm	4050	682*	-	-	662*	4050	556	-	-	566
2000 mm	4490	712*	-	746*	699*	4490	447	-	746*	565
1000 mm	4620	872*	-	1057*	941*	4620	452	-	808	548
Ground	4440	846*	2287*	1288*	915*	4440	467	1365	779	538
-1000 mm	4050	885*	2193*	1378*	891*	4050	538	1395	796	550

RATED LIFT CAPACITY - OVER BLADE / BLADE DOWN						RATED LIFT CAPACITY - OVER SIDE / BLADE UP				
E35z - STANDARD ARM, STANDARD COUNTERWEIGHT										
Lift Point Height [H]	Max. radius [R] (mm)	Lift at max. radius (kg)	Lift radius [R] (kg)			Max. radius [R] (mm)	Lift at max. radius (kg)	Lift radius [R] (kg)		
			2000 mm	3000 mm	4000 mm			2000 mm	3000 mm	4000 mm
3000 mm	3950	702*	-	-	-	3950	325	-	-	-
2000 mm	4420	759*	-	869*	759*	4420	257	-	498	317
1000 mm	4560	816*	-	1224*	883*	4560	241	-	458	299
Ground	4420	928*	2017*	1487*	1007*	4420	250	821	431	289
-1000 mm	3950	965*	2283*	1401*	-	3950	302	900	441	-

RATED LIFT CAPACITY - OVER BLADE / BLADE DOWN						RATED LIFT CAPACITY - OVER SIDE / BLADE UP				
E35z - STANDARD ARM, HEAVY COUNTERWEIGHT										
Lift Point Height [H]	Max. radius [R] (mm)	Lift at max. radius (kg)	Lift radius [R] (kg)			Max. radius [R] (mm)	Lift at max. radius (kg)	Lift radius [R] (kg)		
			2000 mm	3000 mm	4000 mm			2000 mm	3000 mm	4000 mm
3000 mm	3950	702*	-	-	-	3950	433	-	-	-
2000 mm	4420	759*	-	869*	759*	4420	351	-	651	422
1000 mm	4560	816*	-	1224*	883*	4560	332	-	611	405
Ground	4420	928*	2283*	1487*	1007*	4420	344	1047	584	395
-1000 mm	3950	965*	2283*	1401*	-	3950	410	1128	594	-

RATED LIFT CAPACITY - OVER BLADE / BLADE DOWN						RATED LIFT CAPACITY - OVER SIDE / BLADE UP				
E35z - LONG ARM, HEAVY COUNTERWEIGHT										
Lift Point Height [H]	Max. radius [R] (mm)	Lift at max. radius (kg)	Lift radius [R] (kg)			Max. radius [R] (mm)	Lift at max. radius (kg)	Lift radius [R] (kg)		
			2000 mm	3000 mm	4000 mm			2000 mm	3000 mm	4000 mm
4000 mm	3480	602*	-	-	-	3480	602*	-	-	-
3000 mm	4330	638*	-	-	612*	4330	473	-	-	552
2000 mm	4760	680*	-	705*	679*	4760	410	-	705*	532
1000 mm	4870	726*	-	1126*	831*	4870	387	-	780	516
Ground	4800	787*	2272*	1448*	980*	4800	395	1293	743	494
-1000 mm	4330	861*	2295*	1509*	961*	4330	456	1372	737	497

\* Rated hydraulic lift capacity. The lifting capacities are based on ISO 10567 and do not exceed 75% of the static tilt load of the machine or 87% of the hydraulic lifting capacity of the machine.



**Bobcat is a Doosan Company.**  
Doosan is a global leader in construction equipment, power & water solutions, engines, and engineering proudly serving customers and communities for more than a century. | Bobcat and the Bobcat logo are registered trademarks of Bobcat Company in the United States and various other countries.  
©2018 Bobcat Company. All Rights Reserved.



**Bobcat**®

[www.bobcat.com](http://www.bobcat.com)

Certain specification(s) are based on engineering calculations and are not actual measurements. Specification(s) are provided for comparison purposes only and are subject to change without notice. Specification(s) for your individual Bobcat equipment will vary based on normal variations in design, manufacturing, operating conditions, and other factors. Pictures of Bobcat units may show other than standard equipment.

