

Grove GMK6400

Product guide

 400 t

 60 m

 12 - 79 m

 136 m



All-Terrain Crane • AT-Kran
Grue Automotrice Routière
Grúa Todo Terreno Rapida • Gru Fuoristrada Veloci
Вездеходный подъемный кран

Contents • Inhalt • Contenu • Contenido Contenuto • Содержание

Highlights • Stärken • Caractéristiques principales • Puntos destacados • Caratteristiche principali • Основные характеристики	3
Dimensions • Abmessungen • Encombrement • Dimensiones • Dimensioni • Размеры	4
Data • Daten • Caractéristiques • Datos • Dati • Данные	5
Dimensions • Abmessungen • Encombrement • Dimensiones • Dimensioni • Размеры	
Counterweight • Gegengewicht • Contrepoids • Contrapesos • Contrappesi • Противовес	6
Megawinglift	7
Auxiliary hoist • Hilfshubwerk • Treui auxiliaire • Cabrestante auxiliar • Argano secondario • Лебедка вспомогательного подъема	7
Transport proposal • Verfahrkonfiguration • Proposition pour le transport • Sugerencia de transporte	
Proposta di trasporto • Предложение по транспорту	8
Luffing jib • Wippspitzenausleger • Volée variable • Plumín de angulación variable • Jib a volata variable • Маневровый гусек	10
Load charts • Traglasten • Capacités de levage • Capacidades • Capacità • Таблицы грузоподъемности	
Working Range • Arbeitsbereiche • Diagramme de levage • Gama de trabajo • Area di lavoro • Грузовысотные характеристики	12
Telescopic Boom • Teleskopausleger • Flèche principale • Pluma telescópica • Braccio telescopico • Телескопическая стрела	13
Working Range • Arbeitsbereiche • Diagramme de levage • Gama de trabajo • Area di lavoro • Грузовысотные характеристики	19
MEGAWINGLIFT • Telescopic boom • Teleskopausleger • Flèche principale • Pluma telescópica • Braccio telescopico • Телескопическая стрела	20
Working Range • Arbeitsbereiche • Diagramme de levage • Gama de trabajo • Area di lavoro • Грузовысотные характеристики	23
Lattice extension • Auslegerverlängerung • Extension treillis • Plumín fijo • Jib • удлинитель стрелы.	24
Working Range • Arbeitsbereiche • Diagramme de levage • Gama de trabajo • Area di lavoro • Грузовысотные характеристики	27
Lattice extension • Auslegerverlängerung • Extension treillis • Plumín fijo • Jib • удлинитель стрелы.	28
Working Range • Arbeitsbereiche • Diagramme de levage • Gama de trabajo • Area di lavoro • Грузовысотные характеристики	29
MEGAWINGLIFT • Lattice extension • Auslegerverlängerung • Extension treillis • Plumín fijo • Jib • удлинитель стрелы.	30
Working Range • Arbeitsbereiche • Diagramme de levage • Gama de trabajo • Area di lavoro • Грузовысотные характеристики	34
MEGAWINGLIFT • Lattice extension • Auslegerverlängerung • Extension treillis • Plumín fijo • Jib • удлинитель стрелы.	35
Working Range • Arbeitsbereiche • Diagramme de levage • Gama de trabajo • Area di lavoro • Грузовысотные характеристики	36
Luffing jib • Wippspitzenausleger • Volée variable • Plumín de angulación variable • Jib a volata variable • Маневровый гусек	37
Working Range • Arbeitsbereiche • Diagramme de levage • Gama de trabajo • Area di lavoro • Грузовысотные характеристики	46
MEGAWINGLIFT • Luffing jib • Wippspitzenausleger • Volée variable • Plumín de angulación variable • Jib a volata variable • Маневровый гусек	47
MEGAWINGLIFT • Heavy Duty Jib • Schwerlastspitze • Flèche haute résistance • Pluma de alta resistencia	
Falcone con braccetto heavy duty • Стрела для тяжелых условий эксплуатации	58
Overview • Übersicht • Tableau synoptique • Resumen de las tablas • Tabella riassuntiva • Общие сведения	61
Specifications	64
Technische Daten	65
Caractéristiques techniques	66
Características	67
Caratteristiche	68
Технические характеристики	69
Notes • Hinweise • Notes • Notas • Note • Примечания	70
Symbols • Symbolerklärung • Glossaire des symboles • Glosario de símbolos • Glossario dei simboli • Символы	71



Manitowoc Crane Care is the Manitowoc's unparalleled product support organisation. Manitowoc Crane Care combines all aspects of parts, service, technical documentation, technical support and training into one organisation. The program includes all of the Manitowoc's brands, which include, Potain, Grove, Manitowoc and National Crane.

For the care of your crane and the prosperity of your business, Manitowoc Crane Care is your single source for customer support. Wherever, whenever, whatever – we're there.

Manitowoc Crane Care vereint alle Serviceleistungen von Manitowoc im Produktsupport vor und nach dem Verkauf: Ersatzteile, Service, technische Dokumentation, technischer Support und Schulung, alles unter einem Dach. Dieser Service erstreckt sich auf alle Marken von Manitowoc: Potain, Grove, Manitowoc und National Crane.

Damit Ihr Kran leistungsfähig bleibt und Ihr Erfolg gesichert ist, bietet Ihnen Manitowoc Crane Care einen umfassenden Support aus einer Hand. Zu jeder Zeit, an jedem Ort, für jeden Fall – wir sind für Sie da.

Organisation hors pair dédiée au support technique des produits de Manitowoc, Manitowoc Crane Care réunit au sein d'une même entité tous les aspects du service : pièces de rechange, service après-vente, publication technique, assistance technique et formation. Ce programme s'adresse à toutes les marques de Manitowoc : Potain, Grove, Manitowoc et National Crane.

Pour assurer l'entretien de vos grues et la prospérité de votre entreprise, Manitowoc Crane Care constitue votre unique interlocuteur du service à la clientèle. Où que vous soyez, quel que soit votre besoin, vous pouvez toujours compter sur nous !

Manitowoc Crane Care, es la organización post-venta y soporte técnico de Manitowoc. Manitowoc Crane Care combina todos los aspectos de piezas de repuesto, servicio, documentación técnica, apoyo técnico y formación en un único lugar. El programa también incluye todas las ramas Manitowoc que engloba Potain, Grove, Manitowoc y National Crane.

Para el cuidado de su grúa y la prosperidad de su negocio, Manitowoc Crane Care, es la forma más sencilla de ayudarlo. Donde sea y cuando sea, nosotros estamos allí.

Manitowoc Crane Care è l'ineguagliabile organizzazione di supporto di Manitowoc. Manitowoc Crane Care gestisce tutte le attività legate a pezzi di ricambio, documentazione tecnica, assistenza tecnica e formazione riunite in un unico punto di riferimento. Questo servizio è attivo per tutti i marchi di Manitowoc e precisamente Potain, Grove, Manitowoc e National Crane.

Per l'assistenza delle Vostre gru e per la redditività dei Vostri investimenti, Manitowoc Crane Care è l'insostituibile Vostra risorsa. In ogni posto, tutte le volte, per qualsiasi necessità – noi ci siamo

Manitowoc Crane Care - это не имеющая аналогов организация, входящая в Manitowoc и осуществляющая техническую поддержку продукции. Manitowoc Crane Care занимается всеми аспектами, связанными с запасными частями, услугами, технической документацией, технической поддержкой и обучением. Программа включает все торговые марки Manitowoc, в том числе, Potain, Grove, Manitowoc и National Crane.

Manitowoc Crane Care является единой точкой контактов для всех клиентов компании, где они могут получить полное обслуживание для используемых ими кранов, что, в свою очередь, обеспечит процветание их бизнеса. Мы всегда там и в тот момент, где и когда мы необходимы.

Highlights • Stärken • Caractéristiques principales • Puntos destacados Caratteristiche principali • Основные характеристики

- Strongest heavy duty 6 axle crane on the market
- Easy logistics and good transportability
- Easy and fast setup
- Self-rigging MegaWingLift (rigging time < 20 min)
- Symmetric 10 t counterweight slabs
- Self-rigging auxiliary hoist
- Strong 79 m luffing jib/64 m fixed lattice extension (shared components)
- MegaDrive – hydrostatic hybrid drive

- Stärkster 6-Achser AT-Kran am Markt
- Optimale Transportabmaße für einfachste Logistik
- Einfacher und schneller Aufbau des Krans
- Selbstrüstender MegaWingLift (Rüstzeit < 20 min)
- Symmetrische 10 t Gegengewichtsplatten
- Selbstrüstendes Hilfshubwerk
- Starke 79 m Wippspitze/64m feste Vorbauspitze (aus gleichen Teilen)
- MegaDrive – hydrostatischer Hybridantrieb

- La plus puissante grue à 6 essieux sur le marché
- Logistique aisée et bonne transportabilité
- Mise en place facile et rapide
- Auto-montage du MegaWingLift (durée de montage < 20 minutes)
- Dalles de contrepoids symétriques de 10 t
- Treuil auxiliaire à auto-montage
- Volée puissante de 79 m/Extension treillis fixe de 64 m (composants partagés)
- MegaDrive – entraînement hydrostatique hybride

- La grúa de 6 ejes de mayor capacidad del mercado
- Fácil logística y buenas aptitudes de transporte
- Instalación fácil y rápida
- MegaWingLift automontable (tiempo de montaje < 20 min)
- Contrapesos simetricos de 10 t
- Cabrestante auxiliar automontable
- Fuerte plumín abatible de 79 m / plumín fijo de 64 m (componentes compartidos)
- MegaDrive – accionamiento hidrostático híbrido

- La più potente gru a 6 assi per servizio pesante sul mercato
- Facile movimentazione e buona trasportabilità
- Allestimento facile e veloce
- MegaWingLift automontante (tempo di allestimento < 20 min)
- Contrappeso con piastre simmetriche da 10 t
- Argano ausiliario automontante
- Robusto Jib a volata variabile da 79 m / Jib fisso da 64 m (componenti comuni)
- MegaDrive – trasmissione idrostatica ibrido

- Самый мощный тяжелый 6-осевой кран на рынке
- Легкое обслуживание и транспортировка
- Легкая и быстрая установка
- Саморазвертывающаяся система MegaWingLift (время развертывания < 20 мин)
- Симметричные 10 т плиты противовеса
- Саморазвертывающаяся вспомогательная лебедка
- Мощная 79 м подъемная стрела/64 м фиксированное решетчатое расширение (общие компоненты)
- MegaDrive – гидростатический привод

Dimensions • Abmessungen • Encombrement
Dimensiones • Dimensioni • Размеры

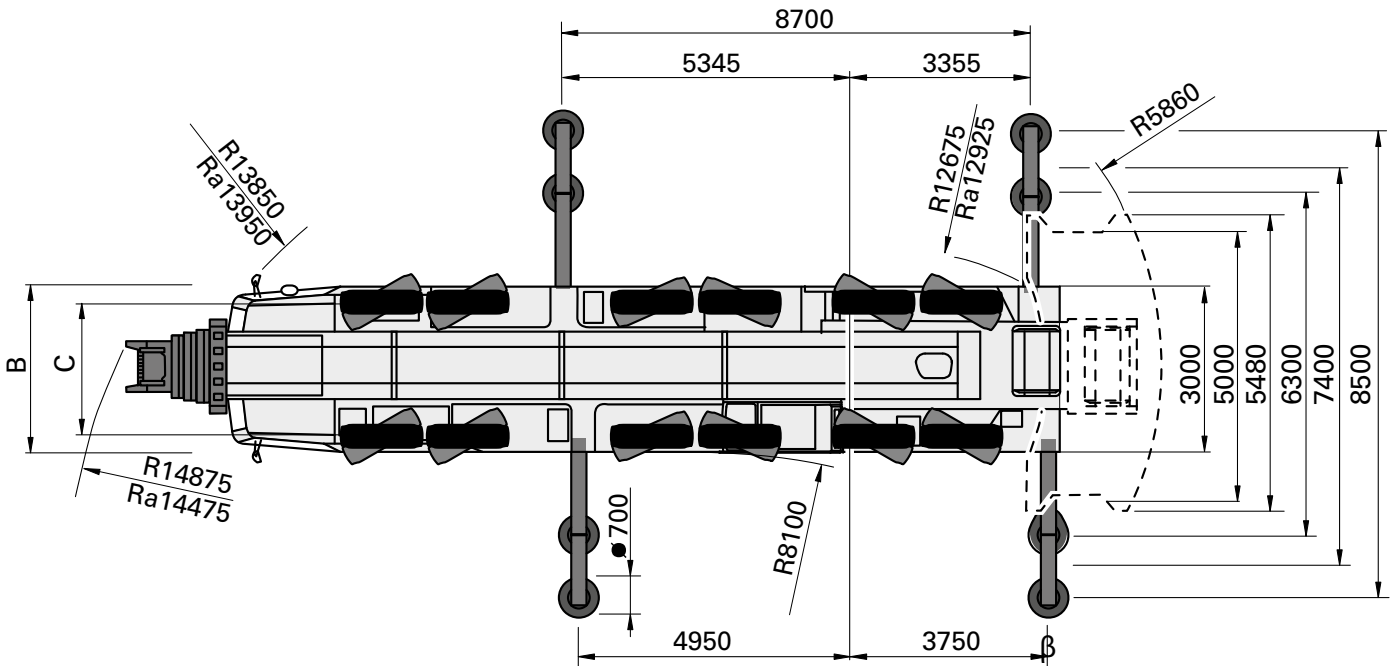
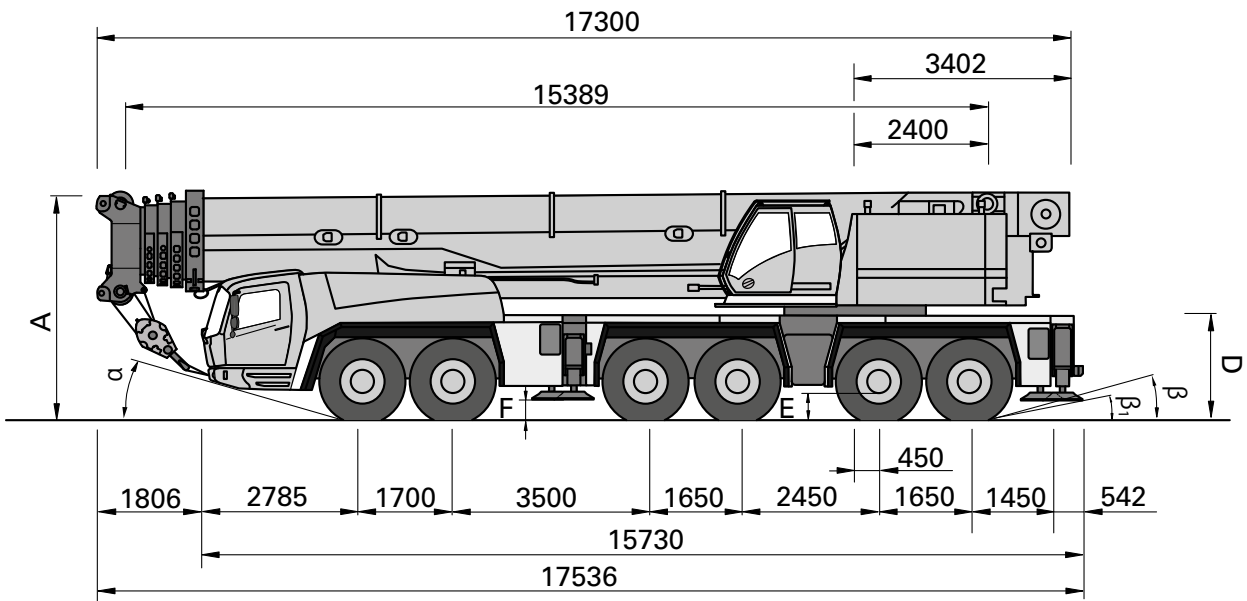

Ra = Radius all wheels steered • Radius allradgelenkt • Rayon toutes les roues directrices • Radio de giro con todas las ruedas giradas • Raggio di curva con tutte le ruote sterzate • Радиус поворота при управлении всеми колесами

	A	A 130 mm**	B	C	D	E	F	α	β	β_1
14.00 R25	3956	3826	2970	2570	1815	400	209	14	11	8
16.00 R25	4000	3870	2975	2510	1865	450	260	16	13	10
20.5 R25	4000	3870	3070	2530	1865	450	260	16	13	10

** Lowered • Abgesenkt • Surbaissée • Rebaja • Abbassato • Спущенный

Data • Daten • Caractéristiques • Datos • Dati • Данные



Axle • Achse Essieu • Eje Asse • Оси	1	2	3	4	5	6	Total weight • Gesamtgewicht Poids total • Peso total Peso totale • Суммарный вес
t	12	12	12	12	12	12	72



Lifting Capacity Traglast Force de levage Capacidad de elevación Capacità di sollevamento Грузоподъемность	Sheaves Rollen Poulies Poleas Carrucolo Шкивы	Weight Gewicht Poids Peso Peso Масса	Parts of line Stränge Brins Ramales de cable Numero di funi Кратность запасовки	Possible load with the crane* Mögliche Traglast am Kran* Capacité possible sur la grue* Carga posible con la grue* Portata ammissibile con la gru* Допустимая нагрузка для крана*
320 t	10	3500 kg	2-20/22 ▪	237t / 255t ▪
250 t	9	3000 kg	2-18	215t
200 t	7	2400 kg	2 - 15	181 t
160 t	5	1800 kg	2 - 11	134 t
100 t	3	1300 kg	2 - 7	87 t
40 t	1	850 kg	1 - 3	38 t
16 t	H/B	450 kg	1	12,5 t

* varies depending on national regulations, variiert je nach Ländervorschrift, fonction des réglementations nationales, variaciones dependiendo de las regulaciones nacionales, varia in funzione delle normative nazionali, изменяется в зависимости от национальных норм.

▪ 0° over rear with additional equipment • Nach hinten mit Zusatzausrüstung • En arrière avec équipement supplémentaires • Per la parte trasera con equipo adicional • Sul posteriore con equipaggiamento ausiliario • Наод задней частью с специальным оборудованием

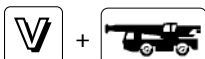

	1	2	3	4	5	6	7	8	9	10	11	12	R	
km/h	5,4	7,0	9,0	11,6	14,7	18,9	25,0	32,0	41,0	53,0	67,0	85,0	6,0	50%
	14.00R25 (385/95R25), 16.00R25 (445/95R25), 20.5R25 (525/80R25)													

* Theoretical gradeability • Theoretisches Steigvermögen • Aptitude théorique en pente • Inclinación teórica • Pendenza teorica • Преодолеваемый уклон (теор.)



	Infinitely variable • Stufenlos Progressivement variable Infinitamente variable • Infinitamente variabile Плавно-изменяемый	Rope • Seil Câble Cable • Fune Канат	Max. Single line pull • Max. Seilzug Effort maxi au brin simple Tiro máximo por ramal • Tiro max. per singola fune Макс. натяжение каната
	0 - 120 m/min Single line • Einfacher Strang Brin simple • Ramal simple • Tiro a fune singola • Однократная запасовка	24 mm / 380 m	125,0 kN
	0 - 120 m/min Single line • Einfacher Strang Brin simple • Ramal simple • Tiro a fune singola • Однократная запасовка	24 mm / 690 m	104,0 kN
	0 - 1 min ⁻¹		
	-1,5° to + 82° approx. 90 s • ca. 90 s env. 90 s • aproximadamente 90 s aproximadamente 90 s • примерно 90 с		
	15,4 to 60,0 m approx. 480 s • ca. 480 s env. 480 s • aproximadamente 480 s aproximadamente 480 s • примерно 480 с		

Dimensions • Abmessungen • Encombrement Dimensiones • Dimensioni • Размеры

Counterweight • Gegengewicht • Contrepoids • Contrapesos • Contrappesi • Противовес

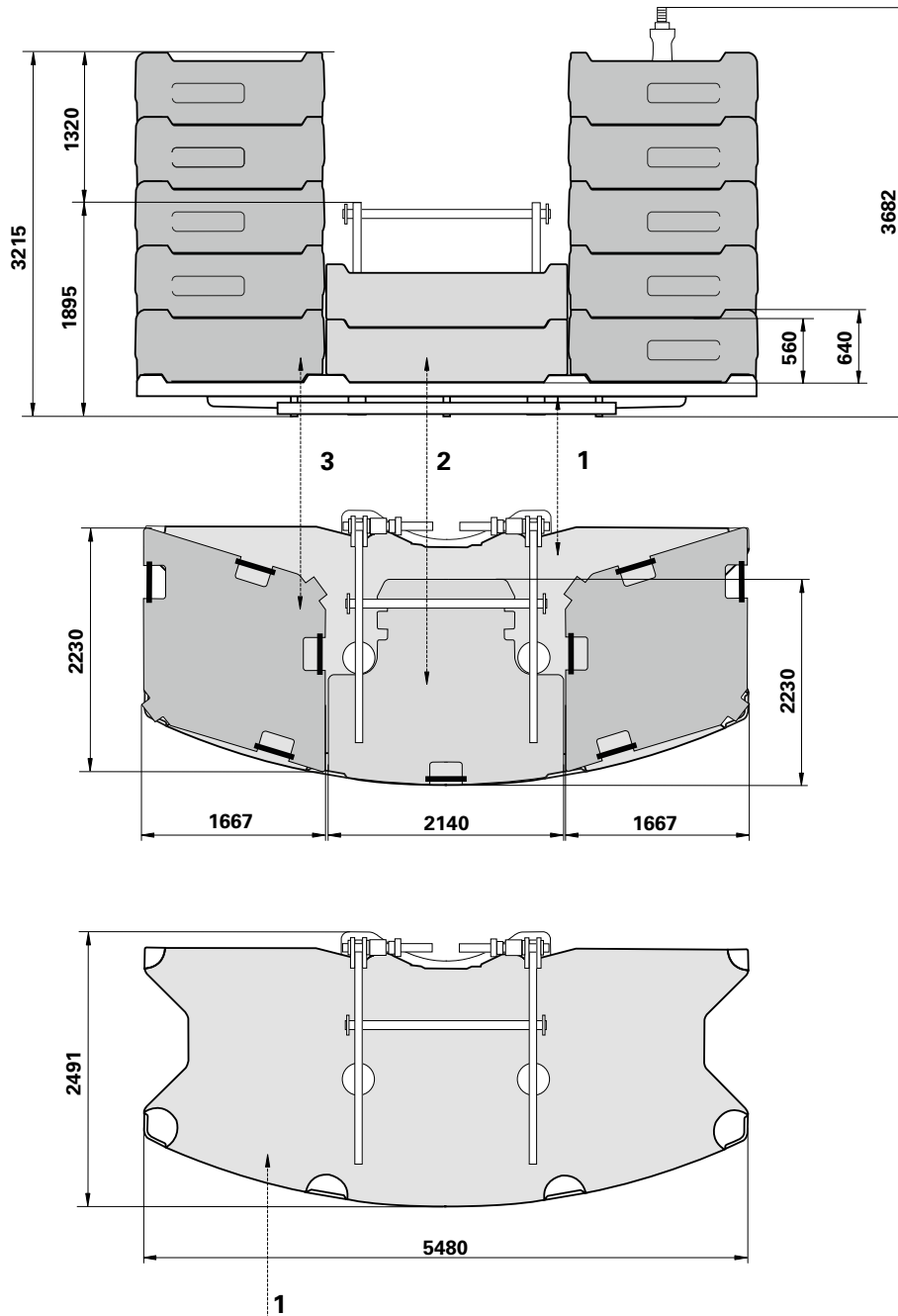

	1 15,0 t	2 10,0 t	3 10,0 t
15,0 t	x	-	-
35,0 t	x	2 x	-
55,0 t	x	2 x	2 x
75,0 t	x	2 x	4 x
95,0 t	x	2 x	6 x
115,0 t	x	2 x	8 x
135,0 t	x	2 x	10 x

Dimensions • Abmessungen • Encombrement
Dimensiones • Dimensioni • Размеры

MEGAWINGLIFT

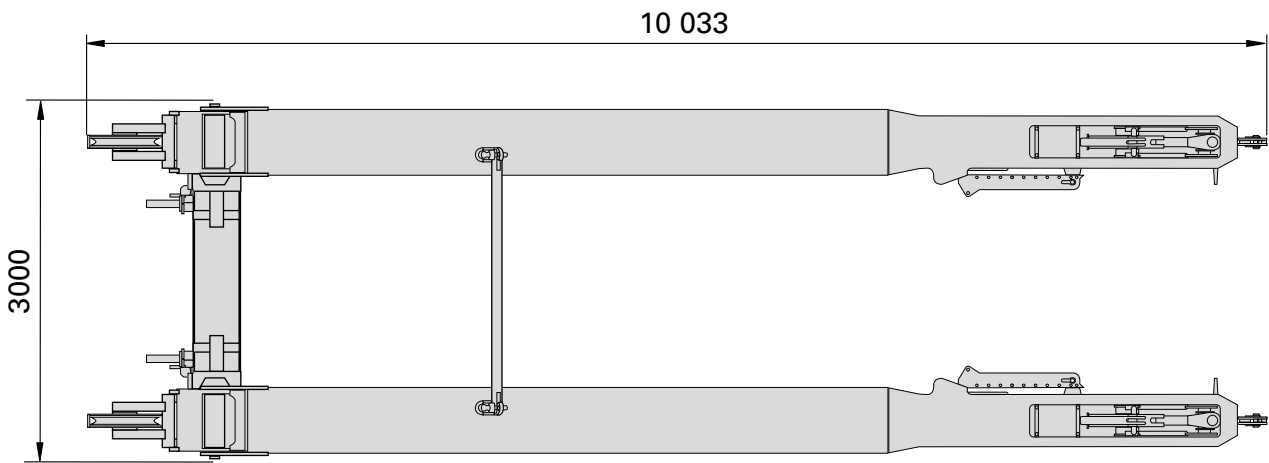
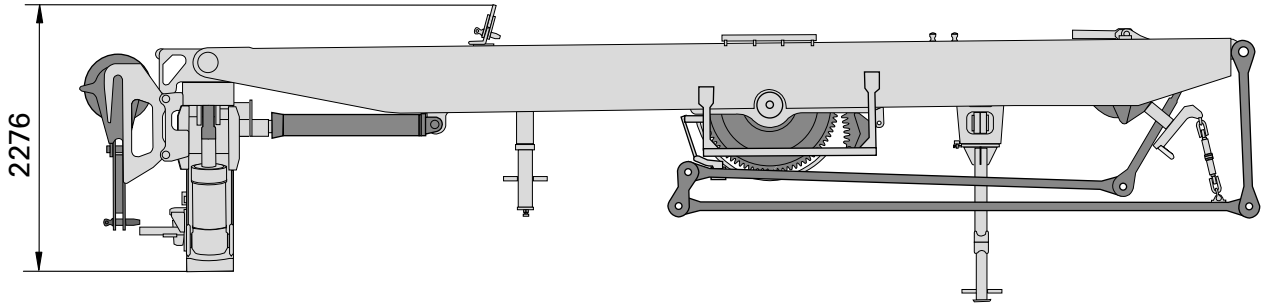

Auxiliary hoist • Hilfshubwerk • Treui auxiliaire • Cabrestante auxiliar • Argano secondario • Лебедка вспомогательного подъема

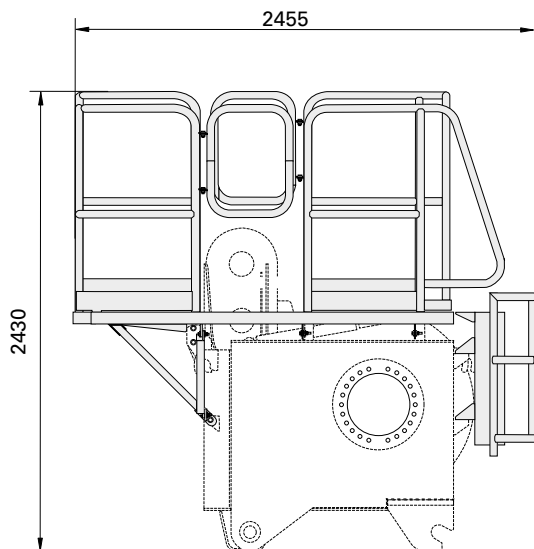

4

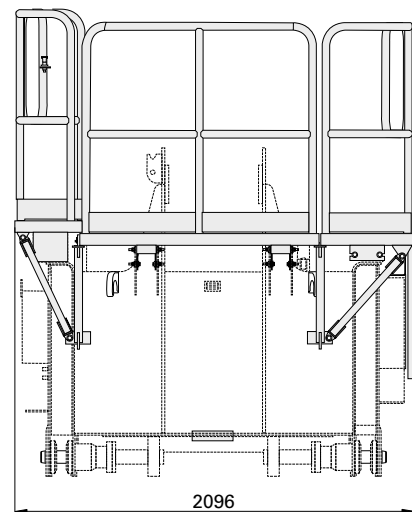

Dimensions • Abmessungen • Encombrement Dimensiones • Dimensioni • Размеры

Transport proposal • Verfahrkonfiguration • Proposition pour le transport • Sugerencia de transporte • Proposta di trasporto • Предложение по транспорту

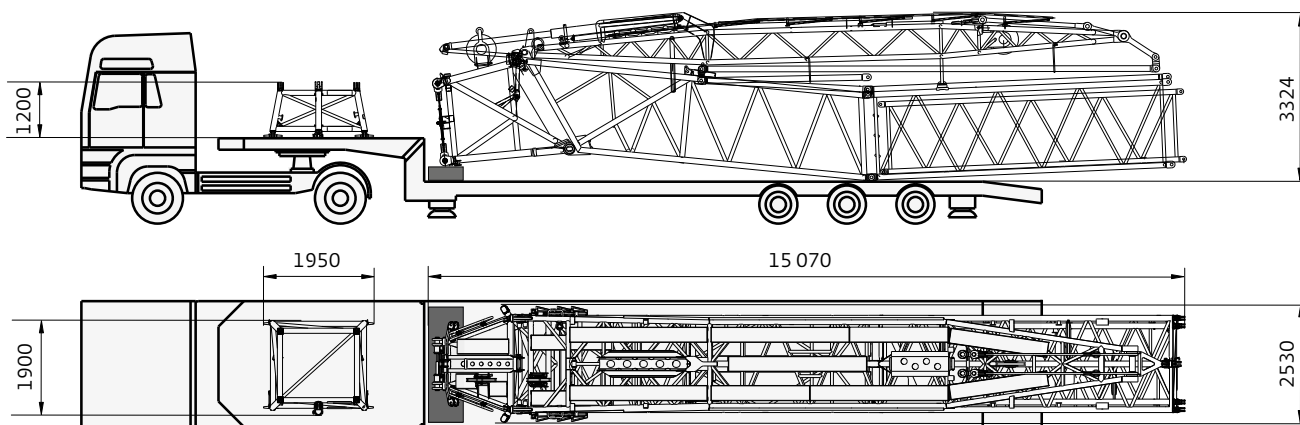

A	B	C	D	L	H
2000 kg	1800 kg	750 kg	1000 kg	2900 kg	400 kg

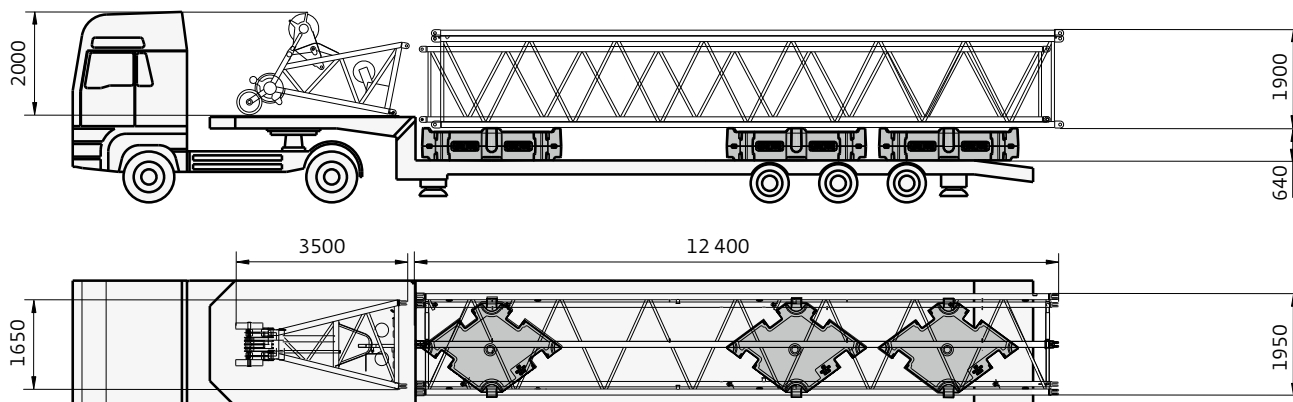

F	E	I
1750 kg	1500 kg	1000 kg

Dimensions • Abmessungen • Encombrement Dimensiones • Dimensioni • Размеры

Transport proposal • Verfahrkonfiguration • Proposition pour le transport • Sugerencia de transporte • Proposta di trasporto • Предложение по транспорту

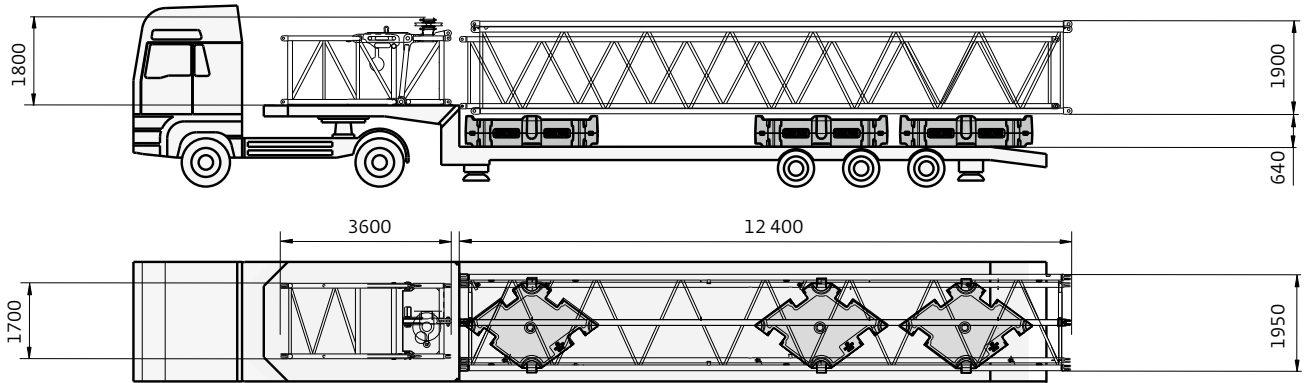

F	E	G
1750 kg	1500 kg	1500 kg

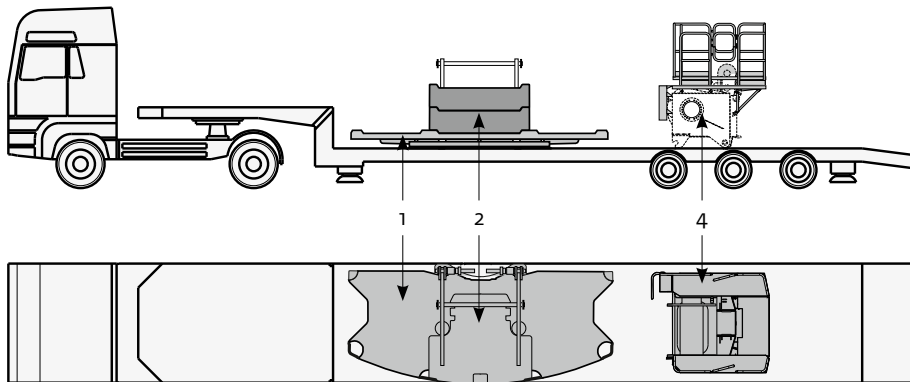

1	2	4
15 t	10 t	5 t

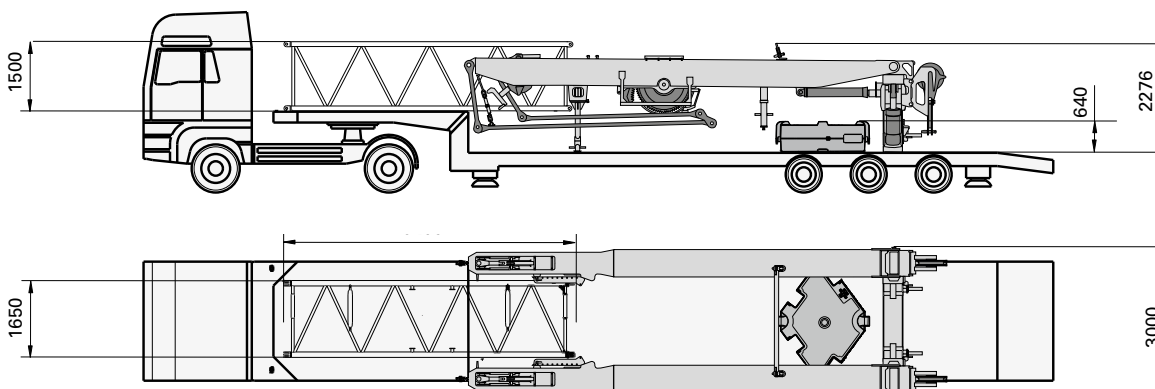

Megawinglift	C
11 t	750 kg

Dimensions • Abmessungen • Encombrement Dimensiones • Dimensioni • Размеры

Luffing jib • Wippspitzenausleger • Volée variable • Plumín de angulación variable • Jib a volata variable • Маневровый гусек

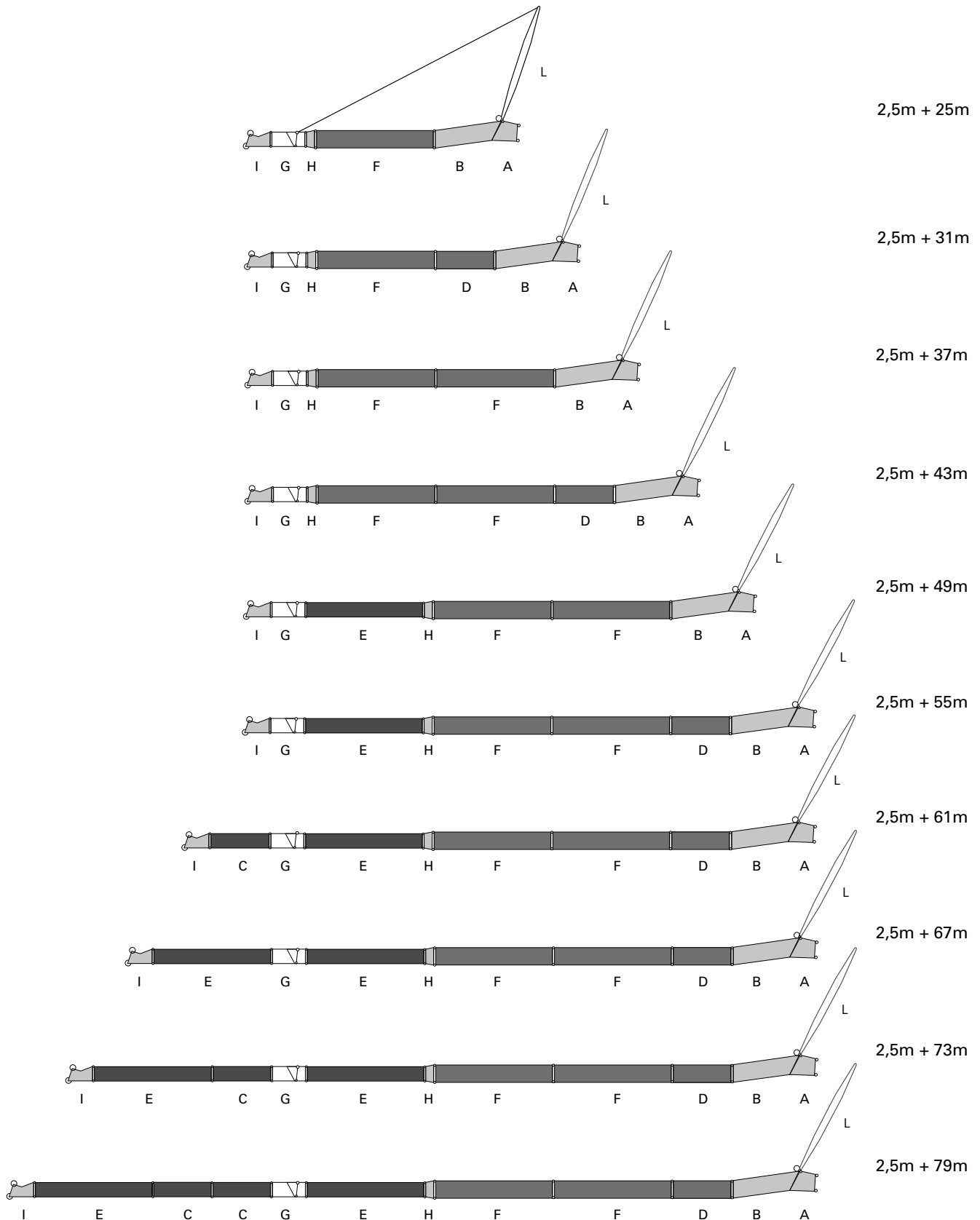

Dimensions • Abmessungen • Encombement Dimensiones • Dimensioni • Размеры

Luffing jib • Wippspitzenausleger • Volée variable • Plumín de angulación variable • Jib físsio • Маневровый гусек

	LxWxH (m)	kg
A	2,8x2,5x2,3	2000
B	6,0x2,1x2,5	1800
C	6,2x1,7x1,5	750
D	6,2x1,9x1,9	1000
E	12,2x1,7x1,6	1500
F	12,2x1,9x1,9	1750
G	3,6x1,7x1,8	1500
H	1,2x1,9x1,9	400
I	3,2x1,6x2,1	1000
L	14,3x2,0x1,6	2900

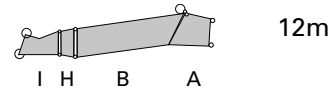

12m

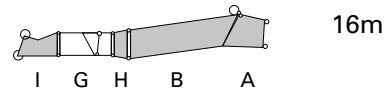

16m

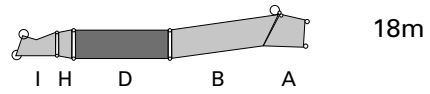

18m

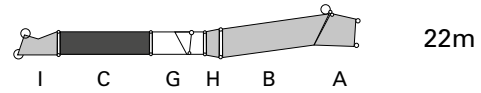

22m

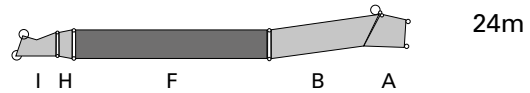

24m

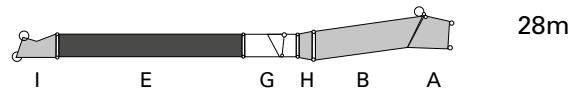

28m

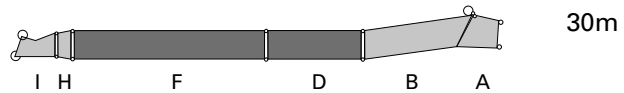

30m

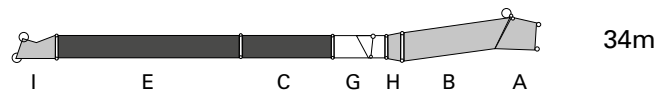

34m



36m



40m



42m



46m



52m



58m

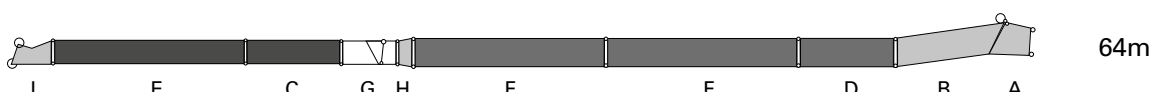

64m

Load charts • Traglasten • Capacités de levage Capacidades • Capacità • Таблицы грузоподъемности

Working range • Arbeitsbereiche • Diagramme de levage • Gama de trabajo • Area di lavoro • Грузовысотные характеристики



15,39 – 60,0 m



8,5 m



360°

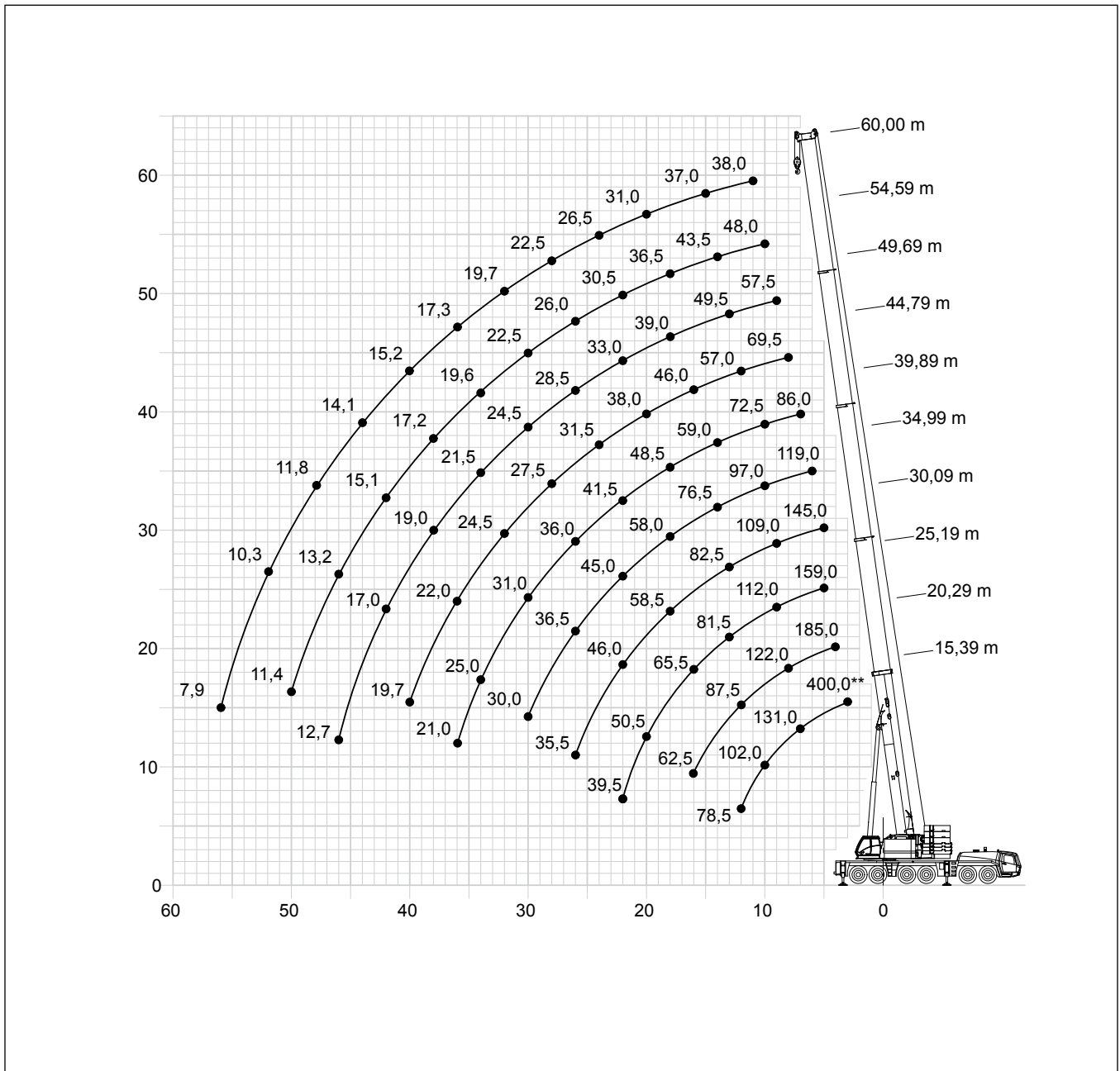

	Hook block • Hakenflasche • Crochet-moufle • Gancho • Ganci • Крюковой блок (t)	H (mm)
	320 D	4050
	250 D	3950
	200 D	3650
	160 D	3650
	100 D/S	3300
	40 D/S	3200
	16 H/B	2600

Load charts • Traglasten • Capacités de levage Capacidades • Capacità • Таблицы грузоподъемности

Telescopic boom • Teleskopausleger • Flèche principale • Pluma telescópica • Braccio telescopico • Телескопическая стрела



15,39 - 60,0 m



8,5 m



360°



135 t



EN 13000

m	15,39*	15,39	20,29	25,19	30,09	34,99	39,89	44,79	49,69	54,59	58,65	60,00	m
2,4	400,0**	-	-	-	-	-	-	-	-	-	-	-	2,4
3,0	-	-	-	-	-	-	-	-	-	-	-	-	3,0
4,0	-	-	-	-	-	-	-	-	-	-	-	-	4,0
5,0	-	-	-	-	-	-	-	-	-	-	-	-	5,0
6,0	-	-	-	-	-	-	-	-	-	-	-	-	6,0
7,0	-	-	-	-	-	-	-	-	-	-	-	-	7,0
8,0	-	123,0	122,0	121,0	-	-	-	-	-	-	-	-	8,0
9,0	-	112,0	112,0	112,0	107,0	-	77,0	67,0	-	-	-	-	9,0
10,0	-	102,0	103,0	103,0	101,0	97,0	72,5	64,0	56,0	-	-	-	10,0
11,0	-	93,5	94,5	94,5	94,5	91,5	69,0	60,5	54,0	47,5	40,0	38,0	11,0
12,0	-	78,5	87,5	87,5	89,0	86,5	65,5	57,0	52,0	46,5	40,0	38,0	12,0
13,0	-	-	81,0	81,5	82,5	82,0	62,0	54,0	49,5	45,0	40,0	38,0	13,0
14,0	-	-	75,5	75,5	77,0	76,5	59,0	51,0	47,0	43,5	39,5	38,0	14,0
15,0	-	-	69,5	70,5	72,0	71,0	56,0	48,5	44,5	41,5	38,5	37,0	15,0
16,0	-	-	62,5	65,5	67,0	66,0	53,5	46,0	42,5	40,0	37,0	36,0	16,0
18,0	-	-	-	57,5	58,5	58,0	48,5	41,5	39,0	36,5	34,5	33,5	18,0
20,0	-	-	-	50,5	52,0	51,0	44,5	38,0	35,5	33,5	31,5	31,0	20,0
22,0	-	-	-	40,0	46,0	45,0	41,5	34,0	33,0	30,5	29,0	28,5	22,0
24,0	-	-	-	-	41,0	40,5	38,5	31,5	30,5	28,5	27,0	26,5	24,0
26,0	-	-	-	-	35,5	36,5	36,0	29,5	28,5	26,5	25,0	24,5	26,0
28,0	-	-	-	-	-	33,0	34,0	27,5	26,5	24,5	23,5	22,5	28,0
30,0	-	-	-	-	-	30,0	31,0	26,0	24,5	23,0	21,5	21,0	30,0
32,0	-	-	-	-	-	-	28,5	24,5	23,0	21,5	20,0	19,7	32,0
34,0	-	-	-	-	-	-	25,0	23,0	21,5	20,0	18,8	18,4	34,0
36,0	-	-	-	-	-	-	21,0	22,0	20,0	19,1	17,7	17,3	36,0
38,0	-	-	-	-	-	-	-	21,0	19,0	18,0	16,6	16,2	38,0
40,0	-	-	-	-	-	-	-	19,7	17,9	16,9	15,5	15,2	40,0
42,0	-	-	-	-	-	-	-	-	17,0	16,0	14,7	14,3	42,0
44,0	-	-	-	-	-	-	-	-	16,0	15,1	13,8	13,4	44,0
46,0	-	-	-	-	-	-	-	-	12,7	14,4	12,9	12,6	46,0
48,0	-	-	-	-	-	-	-	-	-	13,7	12,1	11,8	48,0
50,0	-	-	-	-	-	-	-	-	-	11,4	11,2	10,9	50,0
52,0	-	-	-	-	-	-	-	-	-	-	10,6	10,3	52,0
54,0	-	-	-	-	-	-	-	-	-	-	9,9	9,7	54,0
56,0	-	-	-	-	-	-	-	-	-	-	-	7,9	56,0

* Over rear • Nach hinten • En arrière • Por la parte trasera • Sul posteriore • Над задней частью

** Over rear with special equipment • Nach hinten mit Sonderausüstung • En arrière avec équipement supplémentaire • Por la parte trasera con equipo adicional • Sul posteriore con equipaggiamento ausiliario • Над задней частью с специальным оборудованием

Load charts • Traglasten • Capacités de levage Capacidades • Capacità • Таблицы грузоподъемности

Telescopic boom • Teleskopausleger • Flèche principale • Pluma telescópica • Braccio telescopico • Телескопическая стрела



15,39 - 60,0 m



8,5 m



360°



115 t



EN 13000

m	15,39	20,29	25,19	30,09	34,99	39,89	44,79	49,69	54,59	58,65	60,00	m
5,0	170,0	167,0	157,0	-	-	-	-	-	-	-	-	5,0
6,0	150,0	150,0	144,0	137,0	119,0	-	-	-	-	-	-	6,0
7,0	134,0	134,0	132,0	125,0	119,0	86,0	-	-	-	-	-	7,0
8,0	120,0	121,0	121,0	116,0	112,0	82,0	69,5	-	-	-	-	8,0
9,0	109,0	110,0	110,0	109,0	104,0	77,0	67,0	57,5	-	-	-	9,0
10,0	100,0	101,0	101,0	101,0	97,0	72,5	64,0	56,0	48,0	-	-	10,0
11,0	92,0	92,5	93,0	94,0	91,5	69,0	60,5	54,0	47,5	40,0	38,0	11,0
12,0	78,5	85,0	85,0	86,5	85,0	65,5	57,0	52,0	46,5	40,0	38,0	12,0
13,0	-	78,0	78,0	79,0	78,5	62,0	54,0	49,5	45,0	40,0	38,0	13,0
14,0	-	72,0	72,0	73,0	72,5	59,0	51,0	47,0	43,5	39,5	38,0	14,0
15,0	-	67,0	66,0	67,5	67,0	56,0	48,5	44,5	41,5	38,5	37,0	15,0
16,0	-	62,0	62,0	62,5	61,5	53,5	46,0	42,5	40,0	37,0	36,0	16,0
18,0	-	-	54,0	54,0	53,0	48,5	41,5	39,0	36,5	34,5	33,5	18,0
20,0	-	-	47,5	47,0	46,5	44,5	38,0	35,5	33,5	31,5	31,0	20,0
22,0	-	-	39,5	41,5	41,0	41,5	34,0	33,0	30,5	29,0	28,5	22,0
24,0	-	-	-	37,5	36,5	37,5	31,5	30,5	28,5	27,0	26,5	24,0
26,0	-	-	-	33,5	33,0	33,5	29,5	28,5	26,5	25,0	24,5	26,0
28,0	-	-	-	-	30,5	30,5	27,5	26,5	24,5	23,5	22,5	28,0
30,0	-	-	-	-	28,5	28,0	26,0	24,5	23,0	21,5	21,0	30,0
32,0	-	-	-	-	-	25,5	24,5	23,0	21,5	20,0	19,7	32,0
34,0	-	-	-	-	-	23,5	23,0	21,5	20,0	18,8	18,4	34,0
36,0	-	-	-	-	-	21,0	21,5	20,0	19,1	17,7	17,3	36,0
38,0	-	-	-	-	-	-	19,7	19,0	18,0	16,6	16,2	38,0
40,0	-	-	-	-	-	-	18,1	17,9	16,9	15,5	15,2	40,0
42,0	-	-	-	-	-	-	-	16,5	16,0	14,7	14,3	42,0
44,0	-	-	-	-	-	-	-	15,2	15,1	13,8	13,4	44,0
46,0	-	-	-	-	-	-	-	12,7	14,2	12,9	12,6	46,0
48,0	-	-	-	-	-	-	-	-	13,2	12,1	11,8	48,0
50,0	-	-	-	-	-	-	-	-	11,3	11,2	10,9	50,0
52,0	-	-	-	-	-	-	-	-	-	10,6	10,3	52,0
54,0	-	-	-	-	-	-	-	-	-	9,8	9,7	54,0
56,0	-	-	-	-	-	-	-	-	-	-	7,9	56,0

Load charts • Traglasten • Capacités de levage Capacidades • Capacità • Таблицы грузоподъемности

Telescopic boom • Teleskopausleger • Flèche principale • Pluma telescópica • Braccio telescopico • Телескопическая стрела



15,39 - 60,0 m



8,5 m



360°



95 t



EN 13000

m	15,39	20,29	25,19	30,09	34,99	39,89	44,79	49,69	54,59	58,65	60,00	m
3,0	225,0	-	-	-	-	-	-	-	-	-	-	3,0
4,0	192,0	187,0	-	-	-	-	-	-	-	-	-	4,0
5,0	167,0	167,0	159,0	145,0	-	-	-	-	-	-	-	5,0
6,0	147,0	148,0	144,0	137,0	119,0	-	-	-	-	-	-	6,0
7,0	131,0	132,0	132,0	125,0	119,0	86,0	-	-	-	-	-	7,0
8,0	118,0	119,0	119,0	116,0	112,0	82,0	69,5	-	-	-	-	8,0
9,0	107,0	108,0	108,0	109,0	104,0	77,0	67,0	56,5	-	-	-	9,0
10,0	96,5	97,0	97,5	98,5	97,0	72,5	64,0	56,0	48,0	-	-	10,0
11,0	87,0	88,0	88,0	89,0	88,5	69,0	60,5	54,0	47,5	40,0	38,0	11,0
12,0	78,0	79,0	79,0	80,5	80,0	65,5	57,0	52,0	46,5	40,0	38,0	12,0
13,0	-	72,5	73,0	73,0	72,5	62,0	54,0	49,5	45,0	40,0	38,0	13,0
14,0	-	66,0	67,0	66,5	66,0	59,0	51,0	47,0	43,5	39,5	38,0	14,0
15,0	-	60,5	61,5	61,0	60,5	56,0	48,5	44,5	41,5	38,5	37,0	15,0
16,0	-	56,0	56,5	56,5	55,5	53,5	46,0	42,5	40,0	37,0	36,0	16,0
18,0	-	-	49,0	48,5	48,0	48,5	41,5	39,0	36,5	34,5	33,5	18,0
20,0	-	-	42,5	42,5	41,5	43,0	38,0	35,5	33,5	31,5	31,0	20,0
22,0	-	-	38,0	37,5	37,0	38,0	34,0	33,0	30,5	29,0	28,5	22,0
24,0	-	-	-	33,0	34,5	33,5	31,5	30,5	28,5	27,0	26,5	24,0
26,0	-	-	-	29,5	30,5	29,5	29,5	28,5	26,5	25,0	24,5	26,0
28,0	-	-	-	-	27,0	26,0	26,5	26,5	24,5	23,5	22,5	28,0
30,0	-	-	-	-	24,5	23,5	24,0	23,5	23,0	21,5	21,0	30,0
32,0	-	-	-	-	-	22,0	21,5	21,5	21,5	20,0	19,7	32,0
34,0	-	-	-	-	-	20,0	19,7	19,2	19,5	18,8	18,4	34,0
36,0	-	-	-	-	-	18,4	18,0	17,8	17,6	17,0	16,9	36,0
38,0	-	-	-	-	-	-	16,4	16,6	16,0	15,4	15,3	38,0
40,0	-	-	-	-	-	-	15,0	15,2	14,6	14,0	13,8	40,0
42,0	-	-	-	-	-	-	-	13,9	13,3	12,7	12,6	42,0
44,0	-	-	-	-	-	-	-	12,8	12,2	11,6	11,4	44,0
46,0	-	-	-	-	-	-	-	11,0	11,2	10,5	10,4	46,0
48,0	-	-	-	-	-	-	-	-	10,2	9,6	9,4	48,0
50,0	-	-	-	-	-	-	-	-	9,4	8,7	8,6	50,0
52,0	-	-	-	-	-	-	-	-	-	7,9	7,7	52,0
54,0	-	-	-	-	-	-	-	-	-	7,2	7,0	54,0
56,0	-	-	-	-	-	-	-	-	-	-	6,3	56,0

Load charts • Traglasten • Capacités de levage Capacidades • Capacità • Таблицы грузоподъемности

Telescopic boom • Teleskopausleger • Flèche principale • Pluma telescópica • Braccio telescopico • Телескопическая стрела



15,39 - 60,0 m



8,5 m



360°



75 t



EN 13000

m	15,39	20,29	25,19	30,09	34,99	39,89	44,79	49,69	54,59	58,65	60,00	m
3,0	221,0	-	-	-	-	-	-	-	-	-	-	3,0
4,0	188,0	187,0	-	-	-	-	-	-	-	-	-	4,0
5,0	164,0	164,0	159,0	145,0	-	-	-	-	-	-	-	5,0
6,0	144,0	145,0	144,0	137,0	119,0	-	-	-	-	-	-	6,0
7,0	128,0	129,0	129,0	125,0	119,0	86,0	-	-	-	-	-	7,0
8,0	114,0	115,0	115,0	116,0	112,0	82,0	69,5	-	-	-	-	8,0
9,0	101,0	102,0	102,0	103,0	102,0	77,0	67,0	57,5	-	-	-	9,0
10,0	88,0	89,0	89,5	91,0	89,5	72,5	64,0	56,0	48,0	-	-	10,0
11,0	78,0	80,0	81,0	80,5	79,5	69,0	60,5	54,0	47,5	40,0	38,0	11,0
12,0	70,0	72,0	72,5	72,5	71,0	65,5	57,0	52,0	46,5	40,0	38,0	12,0
13,0	-	65,0	66,0	65,5	64,5	62,0	54,0	49,5	45,0	40,0	38,0	13,0
14,0	-	59,5	60,0	60,0	58,5	58,0	51,0	47,0	43,5	39,5	38,0	14,0
15,0	-	54,5	55,0	55,0	53,5	53,0	48,5	44,5	41,5	38,5	37,0	15,0
16,0	-	50,0	50,5	50,5	49,0	49,0	45,5	42,5	40,0	37,0	36,0	16,0
18,0	-	-	42,5	42,0	43,5	42,0	40,5	39,0	36,5	34,5	33,5	18,0
20,0	-	-	36,0	36,0	37,0	36,0	36,0	35,0	33,5	31,5	31,0	20,0
22,0	-	-	31,5	32,5	32,0	31,0	31,5	31,0	30,5	29,0	28,5	22,0
24,0	-	-	-	28,5	28,0	28,5	28,0	27,5	27,0	26,0	25,5	24,0
26,0	-	-	-	25,0	24,5	25,0	24,5	24,5	24,0	23,0	23,0	26,0
28,0	-	-	-	-	22,0	22,0	22,5	22,0	21,5	20,5	20,5	28,0
30,0	-	-	-	-	19,9	19,7	20,0	19,5	19,0	18,4	18,2	30,0
32,0	-	-	-	-	-	17,7	18,0	17,5	17,0	16,3	16,1	32,0
34,0	-	-	-	-	-	15,9	16,2	15,7	15,2	14,5	14,3	34,0
36,0	-	-	-	-	-	14,4	14,6	14,1	13,5	12,9	12,7	36,0
38,0	-	-	-	-	-	-	13,3	12,7	12,1	11,4	11,2	38,0
40,0	-	-	-	-	-	-	11,2	11,5	10,8	10,1	9,9	40,0
42,0	-	-	-	-	-	-	-	10,3	9,7	9,0	8,8	42,0
44,0	-	-	-	-	-	-	-	9,4	8,7	8,0	7,8	44,0
46,0	-	-	-	-	-	-	-	7,6	7,8	7,0	6,9	46,0
48,0	-	-	-	-	-	-	-	-	6,9	6,2	6,0	48,0
50,0	-	-	-	-	-	-	-	-	6,2	5,4	5,2	50,0
52,0	-	-	-	-	-	-	-	-	-	4,7	4,5	52,0
54,0	-	-	-	-	-	-	-	-	-	4,1	3,9	54,0
56,0	-	-	-	-	-	-	-	-	-	-	3,3	56,0

Load charts • Traglasten • Capacités de levage Capacidades • Capacità • Таблицы грузоподъемности

Telescopic boom • Teleskopausleger • Flèche principale • Pluma telescópica • Braccio telescopico • Телескопическая стрела



15,39 - 60,0 m



8,5 m



360°



55 t



EN 13000

m	15,39	20,29	25,19	30,09	34,99	39,89	44,79	49,69	54,59	58,65	60,00	m
3,0	217,0	-	-	-	-	-	-	-	-	-	-	3,0
4,0	185,0	185,0	-	-	-	-	-	-	-	-	-	4,0
5,0	160,0	161,0	159,0	145,0	-	-	-	-	-	-	-	5,0
6,0	141,0	142,0	142,0	137,0	119,0	-	-	-	-	-	-	6,0
7,0	123,0	124,0	124,0	123,0	113,0	86,0	-	-	-	-	-	7,0
8,0	104,0	105,0	106,0	103,0	96,0	82,0	69,5	-	-	-	-	8,0
9,0	89,5	92,0	92,5	88,5	82,5	77,0	67,0	57,5	-	-	-	9,0
10,0	78,5	80,5	81,0	77,0	72,0	70,5	64,0	56,0	48,0	-	-	10,0
11,0	68,5	71,5	71,5	68,0	64,5	62,5	58,0	54,0	47,5	40,0	38,0	11,0
12,0	59,0	62,5	63,5	60,5	60,0	56,5	54,0	51,5	46,5	40,0	38,0	12,0
13,0	-	54,5	56,0	54,5	54,0	51,0	49,5	47,5	45,0	40,0	38,0	13,0
14,0	-	48,5	49,5	49,0	49,0	46,0	45,0	43,5	41,5	39,5	38,0	14,0
15,0	-	43,0	44,5	45,5	45,0	43,0	42,0	41,0	38,0	37,5	37,0	15,0
16,0	-	39,0	40,5	41,5	41,0	40,5	38,5	38,5	36,0	34,5	34,0	16,0
18,0	-	-	33,5	34,5	34,0	34,5	33,0	33,0	31,0	29,5	29,0	18,0
20,0	-	-	28,0	29,0	29,5	29,0	28,5	28,5	27,0	25,5	25,0	20,0
22,0	-	-	24,0	25,0	25,5	25,0	24,5	24,5	23,5	22,5	22,0	22,0
24,0	-	-	-	22,0	22,0	22,0	21,0	21,0	20,5	19,6	19,2	24,0
26,0	-	-	-	19,0	19,1	19,1	18,1	18,4	17,8	17,1	16,9	26,0
28,0	-	-	-	16,6	16,7	16,7	15,7	16,0	15,4	14,7	14,5	28,0
30,0	-	-	-	-	14,7	14,7	13,7	14,0	13,4	12,7	12,5	30,0
32,0	-	-	-	-	12,9	13,0	12,0	12,3	11,7	11,0	10,8	32,0
34,0	-	-	-	-	-	11,5	10,5	10,8	10,2	9,5	9,3	34,0
36,0	-	-	-	-	-	10,0	9,2	9,4	8,8	8,2	8,0	36,0
38,0	-	-	-	-	-	8,9	8,1	8,3	7,7	7,0	6,8	38,0
40,0	-	-	-	-	-	-	7,0	7,3	6,6	6,0	5,8	40,0
42,0	-	-	-	-	-	-	-	6,4	5,7	5,0	4,8	42,0
44,0	-	-	-	-	-	-	-	5,6	4,9	4,2	4,0	44,0
46,0	-	-	-	-	-	-	-	4,0	4,2	3,4	3,2	46,0
48,0	-	-	-	-	-	-	-	-	3,5	2,8	2,6	48,0
50,0	-	-	-	-	-	-	-	-	2,9	2,1	1,9	50,0
52,0	-	-	-	-	-	-	-	-	-	1,6	-	52,0



15,39 - 60,0 m



8,5 m



360°



35 t



EN 13000

m	15,39	20,29	25,19	30,09	34,99	39,89	44,79	49,69	54,59	58,65	60,00	m
3,0	213,0	-	-	-	-	-	-	-	-	-	-	3,0
4,0	181,0	182,0	-	-	-	-	-	-	-	-	-	4,0
5,0	156,0	157,0	157,0	145,0	-	-	-	-	-	-	-	5,0
6,0	133,0	134,0	127,0	118,0	108,0	-	-	-	-	-	-	6,0
7,0	109,0	109,0	103,0	95,5	88,0	84,5	-	-	-	-	-	7,0
8,0	89,0	90,5	85,5	80,0	74,0	72,0	65,5	-	-	-	-	8,0
9,0	71,0	75,0	72,5	68,0	66,5	62,0	60,0	56,5	-	-	-	9,0
10,0	58,5	62,0	62,5	61,5	58,0	56,0	53,0	52,0	47,0	-	-	10,0
11,0	49,0	52,5	55,0	54,0	51,0	49,5	49,0	46,0	43,0	40,0	38,0	11,0
12,0	41,5	45,0	47,5	48,0	46,5	44,5	44,0	41,5	39,0	36,5	36,0	12,0
13,0	-	39,0	41,5	42,0	41,5	41,5	39,5	37,5	35,0	33,0	32,5	13,0
14,0	-	34,0	36,5	37,0	38,0	37,5	36,0	34,0	32,0	30,0	29,5	14,0
15,0	-	30,0	32,5	33,0	33,5	34,0	33,0	31,0	29,0	27,5	27,0	15,0
16,0	-	26,5	29,0	29,5	30,0	30,5	30,0	28,5	26,5	25,0	24,5	16,0
18,0	-	-	23,5	24,0	24,5	25,0	24,5	24,0	22,5	21,0	20,5	18,0
20,0	-	-	19,3	20,0	20,5	20,5	20,5	19,8	19,0	17,7	17,3	20,0
22,0	-	-	16,1	16,7	17,1	17,2	17,0	16,5	15,8	15,0	14,7	22,0
24,0	-	-	-	14,0	14,5	14,6	14,4	13,8	13,2	12,5	12,3	24,0
26,0	-	-	-	11,9	12,3	12,4	12,2	11,6	11,0	10,3	10,1	26,0
28,0	-	-	-	-	10,4	10,5	10,3	9,8	9,2	8,5	8,3	28,0
30,0	-	-	-	-	8,9	9,0	8,8	8,2	7,6	6,9	6,7	30,0
32,0	-	-	-	-	7,2	7,6	7,4	6,9	6,3	5,6	5,4	32,0
34,0	-	-	-	-	-	6,5	6,3	5,7	5,1	4,5	4,3	34,0
36,0	-	-	-	-	-	5,0	5,3	4,7	4,1	3,4	3,3	36,0
38,0	-	-	-	-	-	-	4,4	3,9	3,2	2,6	2,4	38,0
40,0	-	-	-	-	-	-	2,9	3,1	2,5	1,8	-	40,0
42,0	-	-	-	-	-	-	-	2,4	1,8	-	-	42,0
44,0	-	-	-	-	-	-	-	1,8	-	-	-	44,0

Load charts • Traglasten • Capacités de levage Capacidades • Capacità • Таблицы грузоподъемности

Telescopic boom • Teleskopausleger • Flèche principale • Pluma telescópica • Braccio telescopico • Телескопическая стрела



15,39 - 60,0 m



8,5 m



360°



15 t



EN 13000

m	15,39	20,29	25,19	30,09	34,99	39,89	44,79	49,69	54,59	58,65	60,00	m
3,0	208,0	-	-	-	-	-	-	-	-	-	-	3,0
4,0	177,0	177,0	-	-	-	-	-	-	-	-	-	4,0
5,0	148,0	136,0	124,0	111,0	-	-	-	-	-	-	-	5,0
6,0	109,0	102,0	94,0	85,5	77,0	-	-	-	-	-	-	6,0
7,0	76,0	79,5	75,5	71,5	67,0	63,5	-	-	-	-	-	7,0
8,0	57,0	61,5	62,0	59,5	56,0	55,0	49,0	-	-	-	-	8,0
9,0	44,5	48,5	51,5	50,5	48,0	47,0	42,0	41,0	-	-	-	9,0
10,0	35,5	39,5	42,0	43,0	41,0	40,5	36,0	35,5	32,5	-	-	10,0
11,0	29,0	32,5	35,5	36,5	35,5	35,0	31,5	31,0	28,5	26,5	25,5	11,0
12,0	24,0	27,5	30,0	31,0	31,0	31,0	27,5	27,5	25,0	23,0	22,5	12,0
13,0	-	23,0	25,5	27,0	27,0	27,0	24,5	24,0	22,0	20,5	20,0	13,0
14,0	-	19,8	22,0	23,5	23,5	23,5	22,0	21,5	19,7	18,2	17,7	14,0
15,0	-	17,0	19,4	20,5	20,5	20,5	19,4	19,3	17,6	16,0	15,6	15,0
16,0	-	14,7	16,9	18,0	18,1	18,2	17,1	17,3	15,6	14,2	13,8	16,0
18,0	-	-	13,1	14,1	14,2	14,3	13,2	13,5	12,4	11,1	10,8	18,0
20,0	-	-	10,2	11,1	11,3	11,4	10,3	10,6	9,9	8,7	8,4	20,0
22,0	-	-	7,9	8,8	8,9	9,0	8,0	8,3	7,6	6,8	6,5	22,0
24,0	-	-	-	7,0	7,1	7,1	6,1	6,4	5,8	5,1	4,9	24,0
26,0	-	-	-	5,4	5,5	5,6	4,6	4,9	4,2	3,5	3,3	26,0
28,0	-	-	-	4,2	4,2	4,3	3,3	3,6	3,0	2,3	2,1	28,0
30,0	-	-	-	-	3,1	3,2	2,2	2,5	1,9	-	-	30,0
32,0	-	-	-	-	2,2	2,3	-	-	-	-	-	32,0



15,39 - 60,0 m



8,5 m



360°



0 t



EN 13000

m	15,39	20,29	25,19	30,09	34,99	39,89	44,79	49,69	m
3,0	205,0	-	-	-	-	-	-	-	3,0
4,0	173,0	148,0	-	-	-	-	-	-	4,0
5,0	108,0	98,5	90,0	82,0	-	-	-	-	5,0
6,0	65,5	71,5	67,5	63,0	57,0	-	-	-	6,0
7,0	44,0	49,0	51,5	48,5	45,0	43,5	-	-	7,0
8,0	31,5	36,0	39,5	38,5	36,0	35,5	32,5	-	8,0
9,0	23,5	27,5	30,5	31,5	29,5	29,0	26,5	24,0	9,0
10,0	17,8	21,5	24,5	25,5	24,0	23,5	22,0	19,8	10,0
11,0	13,5	17,0	19,7	21,0	20,0	19,8	18,3	16,5	11,0
12,0	10,2	13,5	16,1	17,3	16,9	16,7	15,4	13,9	12,0
13,0	-	10,8	13,3	14,4	14,4	14,2	13,1	11,7	13,0
14,0	-	8,6	11,0	12,1	12,2	12,1	11,1	9,8	14,0
15,0	-	6,7	9,1	10,1	10,3	10,4	9,5	8,3	15,0
16,0	-	5,2	7,5	8,5	8,7	8,8	8,1	6,9	16,0
18,0	-	-	4,9	5,9	6,0	6,1	5,8	4,8	18,0
20,0	-	-	2,9	3,9	4,0	4,1	3,9	3,1	20,0
22,0	-	-	-	2,4	2,5	2,6	2,4	1,7	22,0

Load charts • Traglasten • Capacités de levage Capacidades • Capacità • Таблицы грузоподъемности

Working range • Arbeitsbereiche • Diagramme de levage • Gama de trabajo • Area di lavoro • Грузовысотные характеристики



34,99 - 60,00 m



8,5 m



360°

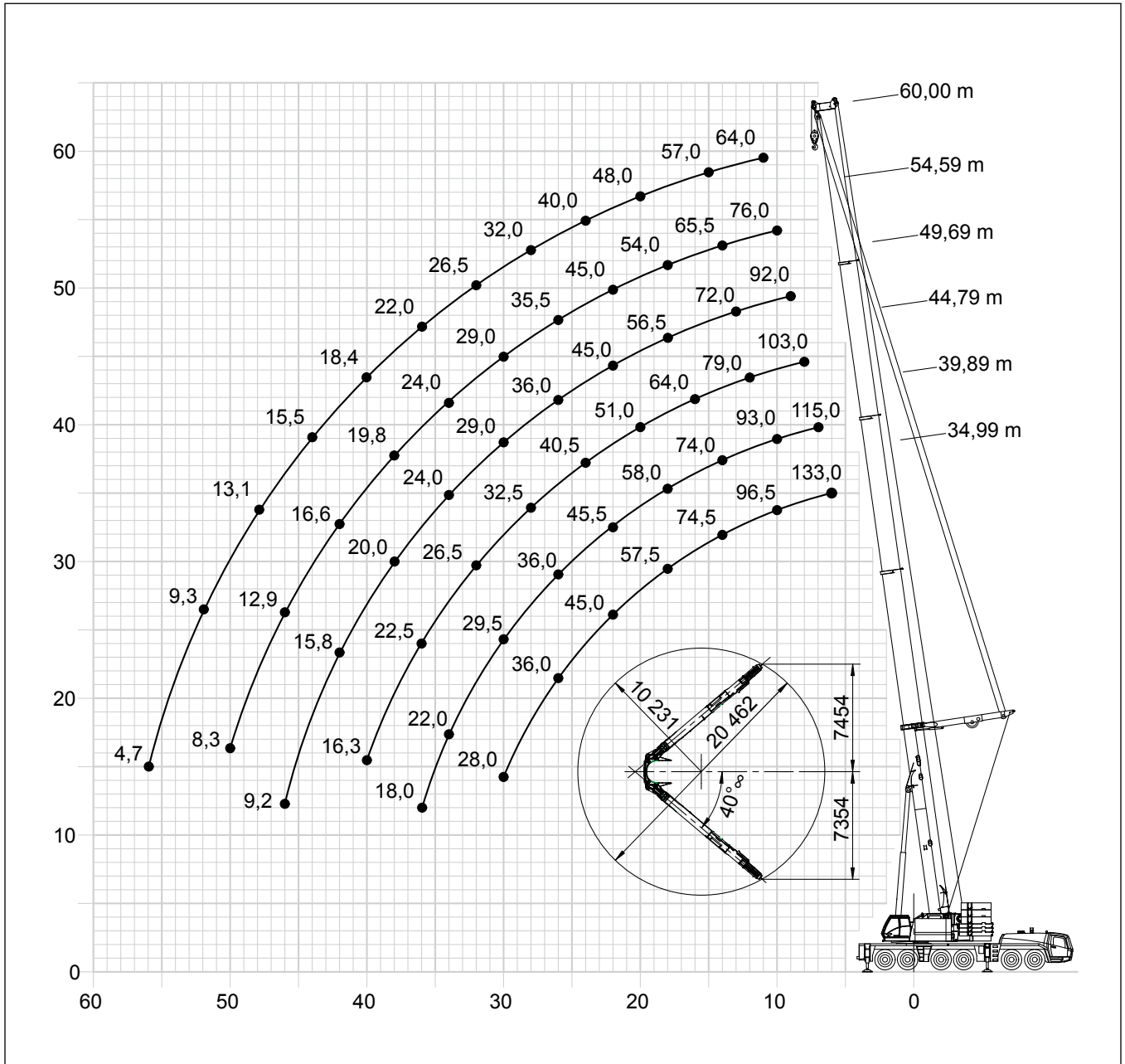

Load charts • Traglasten • Capacités de levage Capacidades • Capacità • Таблицы грузоподъемности

MEGAWINGLIFT

Telescopic boom • Teleskopausleger • Flèche principale • Pluma telescópica • Braccio telescopico • Телескопическая стрела



34,99 - 60,0 m



8,5 m



360°



135 t



EN 13000

m	34,99	39,89	44,79	49,69	54,59	60,00	m
8,0	109,0	105,0	103,0	-	-	-	8,0
9,0	101,0	97,0	94,5	92,0	-	-	9,0
10,0	96,5	93,0	90,0	87,5	76,0	-	10,0
11,0	90,5	87,0	84,0	81,5	76,0	64,0	11,0
12,0	85,5	82,0	79,0	76,5	74,0	64,0	12,0
13,0	80,5	77,5	74,5	72,0	69,5	61,5	13,0
14,0	74,5	74,0	70,5	68,0	65,5	59,5	14,0
15,0	70,0	70,0	67,5	64,5	62,0	57,0	15,0
16,0	65,5	65,5	64,0	61,5	59,0	55,0	16,0
18,0	57,5	58,0	58,0	56,5	54,0	51,5	18,0
20,0	51,0	51,0	51,0	51,0	49,5	48,0	20,0
22,0	45,0	45,5	45,5	45,0	45,0	44,5	22,0
24,0	40,0	40,5	40,5	40,0	40,0	40,0	24,0
26,0	36,0	36,0	36,0	36,0	35,5	36,0	26,0
28,0	31,5	32,5	32,5	32,5	32,0	32,0	28,0
30,0	28,0	29,5	29,5	29,0	29,0	29,0	30,0
32,0	-	26,5	26,5	26,5	26,0	26,5	32,0
34,0	-	22,0	24,5	24,0	24,0	24,0	34,0
36,0	-	18,0	22,5	22,0	21,5	22,0	36,0
38,0	-	-	18,8	20,0	19,8	20,0	38,0
40,0	-	-	16,3	18,5	18,1	18,4	40,0
42,0	-	-	-	15,8	16,6	16,9	42,0
44,0	-	-	-	14,2	15,2	15,5	44,0
46,0	-	-	-	9,2	12,9	14,2	46,0
48,0	-	-	-	-	11,6	13,1	48,0
50,0	-	-	-	-	8,3	11,4	50,0
52,0	-	-	-	-	-	9,3	52,0
54,0	-	-	-	-	-	8,3	54,0
56,0	-	-	-	-	-	4,7	56,0



34,99 - 60,0 m



8,5 m



360°



115 t



EN 13000

m	34,99	39,89	44,79	49,69	54,59	60,00	m
6,0	131,0	-	-	-	-	-	6,0
7,0	121,0	115,0	-	-	-	-	7,0
8,0	111,0	108,0	103,0	-	-	-	8,0
9,0	103,0	100,0	97,0	92,0	-	-	9,0
10,0	96,5	93,0	90,0	87,5	76,0	-	10,0
11,0	90,5	87,0	84,0	81,5	76,0	64,0	11,0
12,0	85,0	82,0	79,0	76,5	74,0	64,0	12,0
13,0	78,5	77,5	74,5	72,0	69,5	61,5	13,0
14,0	72,5	73,0	70,5	68,0	65,5	59,5	14,0
15,0	67,0	67,5	67,5	64,5	62,0	57,0	15,0
16,0	62,5	62,5	62,5	61,5	59,0	55,0	16,0
18,0	53,5	54,0	54,0	53,5	53,0	51,5	18,0
20,0	46,5	47,0	47,0	46,5	46,0	46,5	20,0
22,0	41,0	41,0	41,0	41,0	40,5	41,0	22,0
24,0	36,0	36,5	36,5	36,5	36,0	36,0	24,0
26,0	32,5	32,5	32,5	32,5	32,0	32,5	26,0
28,0	29,0	29,5	29,0	29,0	28,5	29,0	28,0
30,0	26,0	26,5	26,5	26,0	26,0	26,0	30,0
32,0	-	24,0	24,0	23,5	23,5	23,5	32,0
34,0	-	22,0	21,5	21,5	21,0	21,5	34,0
36,0	-	18,0	19,7	19,5	19,1	19,4	36,0
38,0	-	-	17,9	17,7	17,2	17,5	38,0
40,0	-	-	16,2	16,0	15,5	15,8	40,0
42,0	-	-	-	14,4	13,9	14,2	42,0
44,0	-	-	-	13,1	12,6	12,8	44,0
46,0	-	-	-	9,2	11,3	11,6	46,0
48,0	-	-	-	-	10,2	10,4	48,0
50,0	-	-	-	-	8,3	9,4	50,0
52,0	-	-	-	-	-	8,5	52,0
54,0	-	-	-	-	-	7,6	54,0
56,0	-	-	-	-	-	4,7	56,0

Load charts • Traglasten • Capacités de levage Capacidades • Capacità • Таблицы грузоподъемности

MEGAWINGLIFT

Telescopic boom • Teleskopausleger • Flèche principale • Pluma telescópica • Braccio telescopico • Телескопическая стрела



34,99 - 60,0 m



8,5 m



360°



95 t



EN 13000

m	34,99	39,89	44,79	49,69	54,59	60,00	m
6,0	133,0	-	-	-	-	-	6,0
7,0	121,0	115,0	-	-	-	-	7,0
8,0	111,0	108,0	103,0	-	-	-	8,0
9,0	103,0	100,0	97,0	92,0	-	-	9,0
10,0	96,5	93,0	90,0	87,5	76,0	-	10,0
11,0	89,0	87,0	84,0	81,5	76,0	64,0	11,0
12,0	81,0	81,5	79,0	76,5	74,0	64,0	12,0
13,0	73,5	74,0	74,0	72,0	69,5	61,5	13,0
14,0	67,0	67,5	67,5	66,5	64,0	59,5	14,0
15,0	61,5	61,5	61,5	61,0	59,0	57,0	15,0
16,0	56,5	56,5	56,5	56,5	54,5	53,0	16,0
18,0	48,0	48,5	48,5	48,5	47,0	46,0	18,0
20,0	42,0	42,0	42,0	42,0	40,5	40,0	20,0
22,0	36,5	37,0	37,0	36,5	35,5	35,0	22,0
24,0	32,5	32,5	32,5	32,5	31,5	31,0	24,0
26,0	28,5	29,0	29,0	28,5	28,0	27,5	26,0
28,0	25,0	25,5	25,5	25,0	25,0	24,5	28,0
30,0	22,0	22,5	22,5	22,5	22,0	22,0	30,0
32,0	-	20,0	19,9	19,7	19,3	19,6	32,0
34,0	-	17,8	17,7	17,5	17,1	17,4	34,0
36,0	-	15,9	15,8	15,6	15,1	15,5	36,0
38,0	-	-	14,1	13,9	13,4	13,7	38,0
40,0	-	-	12,6	12,4	11,9	12,2	40,0
42,0	-	-	-	11,0	10,6	10,9	42,0
44,0	-	-	-	9,8	9,3	9,6	44,0
46,0	-	-	-	8,7	8,1	8,4	46,0
48,0	-	-	-	-	7,1	7,4	48,0
50,0	-	-	-	-	6,1	6,4	50,0
52,0	-	-	-	-	-	5,5	52,0
54,0	-	-	-	-	-	4,7	54,0
56,0	-	-	-	-	-	3,9	56,0



34,99 - 60,0 m



8,5 m



360°



75 t



EN 13000

m	34,99	39,89	44,79	49,69	54,59	60,00	m
6,0	133,0	-	-	-	-	-	6,0
7,0	121,0	115,0	-	-	-	-	7,0
8,0	111,0	108,0	103,0	-	-	-	8,0
9,0	103,0	100,0	97,0	91,5	-	-	9,0
10,0	92,5	91,0	87,0	83,0	76,0	-	10,0
11,0	82,0	81,0	77,5	74,5	71,0	64,0	11,0
12,0	73,5	72,5	70,0	67,0	64,0	62,0	12,0
13,0	66,5	65,5	63,0	60,5	58,0	56,5	13,0
14,0	60,0	59,5	57,5	55,5	53,0	51,5	14,0
15,0	55,0	54,5	52,5	50,5	48,5	47,5	15,0
16,0	50,5	50,0	48,5	46,5	44,5	43,5	16,0
18,0	43,0	42,5	41,5	40,0	38,0	37,5	18,0
20,0	36,0	36,5	35,5	34,5	33,0	32,5	20,0
22,0	30,5	31,0	31,0	30,0	28,5	28,0	22,0
24,0	26,5	27,0	26,5	26,0	25,0	24,5	24,0
26,0	23,0	23,0	23,0	23,0	22,0	21,5	26,0
28,0	19,7	20,0	20,0	19,9	19,3	19,2	28,0
30,0	17,1	17,6	17,5	17,3	16,8	16,9	30,0
32,0	-	15,3	15,2	15,0	14,5	14,9	32,0
34,0	-	13,3	13,2	13,0	12,5	12,8	34,0
36,0	-	11,6	11,5	11,2	10,7	11,1	36,0
38,0	-	-	10,0	9,7	9,2	9,5	38,0
40,0	-	-	8,6	8,3	7,8	8,1	40,0
42,0	-	-	-	7,1	6,6	6,9	42,0
44,0	-	-	-	6,0	5,5	5,8	44,0
46,0	-	-	-	5,1	4,5	4,8	46,0
48,0	-	-	-	-	3,6	3,9	48,0
50,0	-	-	-	-	2,8	3,0	50,0
52,0	-	-	-	-	-	2,6	52,0
54,0	-	-	-	-	-	1,6	54,0

Load charts • Traglasten • Capacités de levage Capacidades • Capacità • Таблицы грузоподъемности

MEGAWINGLIFT

Telescopic boom • Teleskopausleger • Flèche principale • Pluma telescópica • Braccio telescopico • Телескопическая стрела



34,99 - 60,0 m



8,5 m



360°



55 t



EN 13000

m	34,99	39,89	44,79	49,69	54,59	60,00	m
6,0	133,0	-	-	-	-	-	6,0
7,0	121,0	115,0	-	-	-	-	7,0
8,0	103,0	98,0	93,0	-	-	-	8,0
9,0	88,5	85,0	81,0	77,0	-	-	9,0
10,0	77,5	74,5	71,0	67,5	64,5	-	10,0
11,0	68,5	66,0	63,0	60,5	57,5	55,0	11,0
12,0	61,0	59,0	56,5	54,0	51,5	50,0	12,0
13,0	54,5	53,0	51,0	49,0	46,5	45,5	13,0
14,0	49,5	48,0	46,0	44,5	42,5	41,0	14,0
15,0	44,5	43,5	42,0	40,5	38,5	37,5	15,0
16,0	41,0	40,0	38,5	37,0	35,0	34,5	16,0
18,0	33,5	33,5	32,5	31,0	29,5	29,0	18,0
20,0	27,5	28,0	27,5	26,5	25,5	25,0	20,0
22,0	23,0	23,5	23,5	23,0	21,5	21,5	22,0
24,0	19,3	19,7	19,7	19,5	18,6	18,4	24,0
26,0	16,2	16,6	16,6	16,3	15,8	15,9	26,0
28,0	13,6	14,1	14,0	13,7	13,2	13,6	28,0
30,0	11,4	11,8	11,8	11,5	11,0	11,4	30,0
32,0	-	10,0	9,9	9,6	9,1	9,5	32,0
34,0	-	8,3	8,2	8,0	7,5	7,8	34,0
36,0	-	6,9	6,8	6,5	6,0	6,4	36,0
38,0	-	-	5,5	5,3	4,7	5,1	38,0
40,0	-	-	4,4	4,1	3,6	4,0	40,0
42,0	-	-	-	3,1	2,6	2,9	42,0
44,0	-	-	-	2,2	1,7	2,0	44,0



34,99 - 60,0 m



8,5 m



360°



35 t



EN 13000

m	34,99	39,89	44,79	49,69	54,59	60,00	m
6,0	119,0	-	-	-	-	-	6,0
7,0	97,0	91,5	-	-	-	-	7,0
8,0	81,5	77,5	73,0	-	-	-	8,0
9,0	69,5	66,5	63,0	59,5	-	-	9,0
10,0	60,0	58,0	55,0	52,5	49,5	-	10,0
11,0	53,0	51,0	48,5	46,5	44,0	42,5	11,0
12,0	46,5	45,0	43,5	41,0	39,0	38,0	12,0
13,0	41,5	40,5	38,5	37,0	35,0	34,0	13,0
14,0	37,5	36,5	35,0	33,0	31,5	30,5	14,0
15,0	33,0	32,5	31,5	30,0	28,5	28,0	15,0
16,0	29,5	29,5	28,5	27,0	25,5	25,0	16,0
18,0	23,0	23,5	23,5	22,5	21,0	21,0	18,0
20,0	18,5	19,0	18,9	18,7	17,6	17,4	20,0
22,0	14,8	15,3	15,2	15,0	14,5	14,4	22,0
24,0	11,8	12,3	12,3	12,0	11,5	11,9	24,0
26,0	9,4	9,9	9,8	9,6	9,1	9,5	26,0
28,0	7,3	7,8	7,8	7,5	7,0	7,4	28,0
30,0	5,6	6,1	6,0	5,8	5,3	5,6	30,0
32,0	-	4,6	4,5	4,3	3,8	4,1	32,0
34,0	-	3,3	3,2	3,0	2,4	2,8	34,0
36,0	-	2,2	2,1	1,8	-	1,7	36,0

Load charts • Traglasten • Capacités de levage Capacidades • Capacità • Таблицы грузоподъемности

Lattice extension • Auslegerverlängerung • Extension treillis • Plumín fijo • Jib • удлинитель стрелы



54,59 m



12,0 - 64,0 m



8,5 m



360°

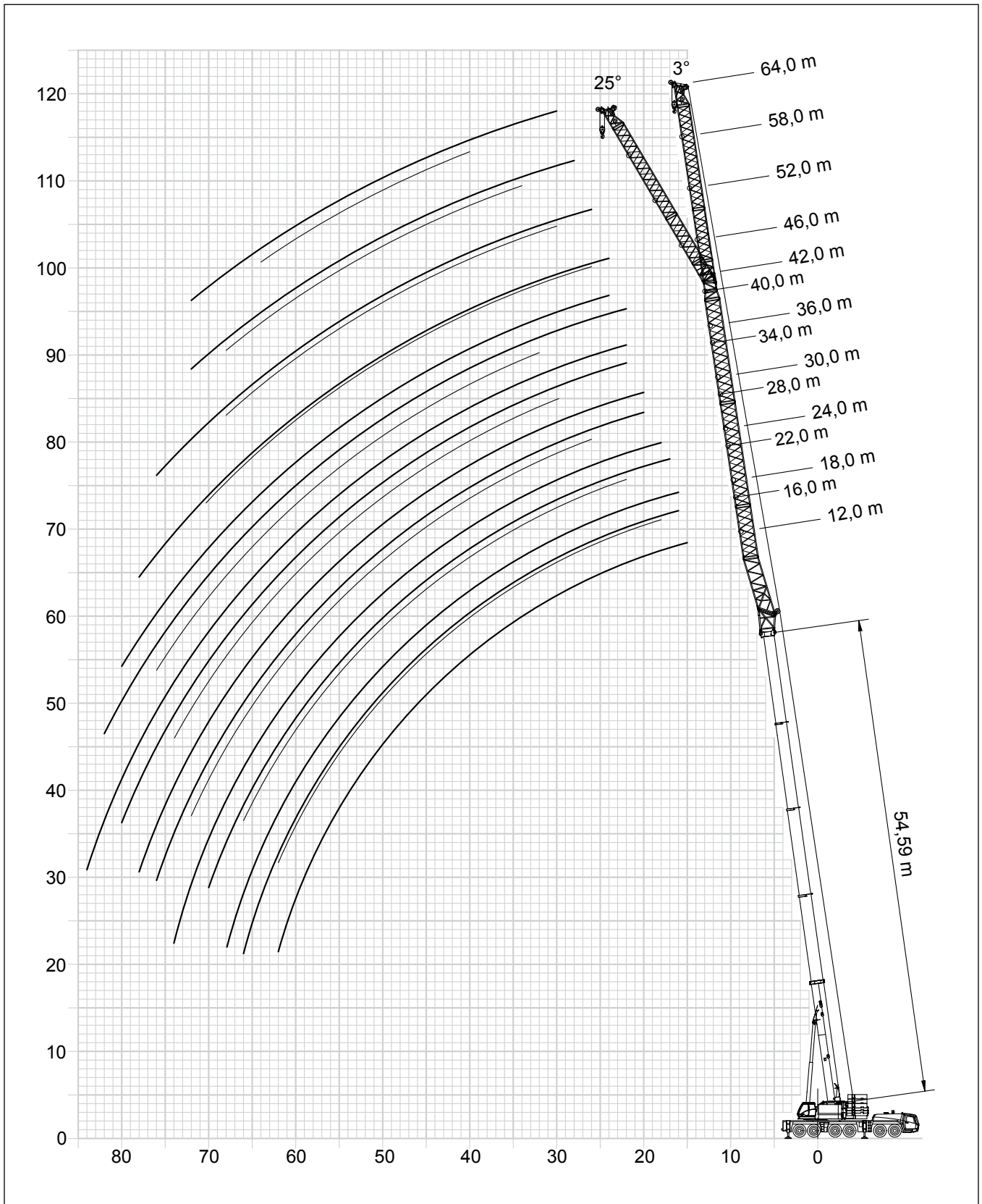

Load charts • Traglasten • Capacités de levage Capacidades • Capacità • Таблицы грузоподъемности

Lattice extension • Auslegerverlängerung • Extension treillis • Plumín fijo • Jib • удлинитель стрелы



49,69 m



3°
12,0 - 64,0 m



8,5 m



360°



135 t



EN 13000

m	12,00	16,00	22,00	28,00	34,00	40,00	46,00	52,00	58,00	64,00	m
13,0	34,5	-	-	-	-	-	-	-	-	-	13,0
14,0	34,5	30,0	-	-	-	-	-	-	-	-	14,0
15,0	34,0	30,0	-	-	-	-	-	-	-	-	15,0
16,0	33,0	30,0	24,0	-	-	-	-	-	-	-	16,0
18,0	31,0	28,5	24,0	18,5	-	-	-	-	-	-	18,0
20,0	28,5	26,5	23,5	17,8	15,0	-	-	-	-	-	20,0
22,0	26,0	24,5	22,0	17,1	14,4	12,0	10,5	-	-	-	22,0
24,0	24,0	22,5	21,0	16,5	13,8	11,5	10,1	8,5	-	-	24,0
26,0	22,0	20,5	19,7	15,8	13,3	11,1	9,7	8,1	7,0	-	26,0
28,0	20,5	19,1	18,5	15,3	12,8	10,6	9,3	7,8	6,7	5,9	28,0
30,0	18,8	17,6	17,1	14,7	12,1	10,2	8,9	7,4	6,4	5,6	30,0
32,0	17,5	16,3	15,9	14,2	11,6	9,8	8,5	7,1	6,1	5,3	32,0
34,0	16,2	15,1	14,7	13,7	11,2	9,4	8,1	6,8	5,8	5,1	34,0
36,0	15,1	13,9	13,6	12,9	10,8	9,1	7,8	6,5	5,5	4,8	36,0
38,0	14,0	12,8	12,6	12,1	10,4	8,7	7,5	6,2	5,3	4,6	38,0
40,0	13,0	11,7	11,5	11,4	10,0	8,4	7,1	5,9	5,0	4,4	40,0
42,0	12,0	10,9	10,7	10,6	9,7	8,1	6,9	5,7	4,8	4,1	42,0
44,0	11,1	10,1	10,0	9,9	9,4	7,8	6,6	5,4	4,6	3,9	44,0
46,0	10,2	9,3	9,2	9,2	9,1	7,6	6,3	5,2	4,4	3,7	46,0
48,0	9,5	8,6	8,6	8,6	8,5	7,3	6,1	5,0	4,1	3,5	48,0
50,0	8,7	7,9	7,9	8,0	7,9	7,1	5,8	4,7	3,9	3,3	50,0
52,0	8,1	7,3	7,3	7,4	7,3	6,8	5,6	4,5	3,7	3,2	52,0
54,0	7,5	6,8	6,8	6,9	6,8	6,5	5,4	4,3	3,6	3,0	54,0
56,0	6,9	6,2	6,3	6,4	6,4	6,1	5,2	4,1	3,4	2,8	56,0
58,0	4,8	5,7	5,8	5,9	5,9	5,8	5,0	4,0	3,2	2,7	58,0
60,0	-	5,1	5,3	5,4	5,4	5,4	4,8	3,8	3,1	2,6	60,0
62,0	-	-	4,9	5,0	5,0	5,0	4,4	3,6	2,9	2,4	62,0
64,0	-	-	4,4	4,6	4,6	4,6	4,1	3,5	2,8	2,3	64,0
66,0	-	-	3,9	4,2	4,2	4,3	3,7	3,3	2,7	2,1	66,0
68,0	-	-	-	3,8	3,9	3,9	3,4	3,1	2,5	2,0	68,0
70,0	-	-	-	3,4	3,5	3,6	3,0	2,8	2,4	1,9	70,0
72,0	-	-	-	2,7	3,2	3,3	2,8	2,4	2,3	1,8	72,0
74,0	-	-	-	-	2,9	3,0	2,5	2,1	2,1	1,7	74,0
76,0	-	-	-	-	2,5	2,7	2,2	1,9	1,9	-	76,0
78,0	-	-	-	-	-	2,4	1,9	1,6	-	-	78,0
80,0	-	-	-	-	-	2,1	1,6	-	-	-	80,0
82,0	-	-	-	-	-	1,8	-	-	-	-	82,0

Load charts • Traglasten • Capacités de levage Capacidades • Capacità • Таблицы грузоподъемности

Lattice extension • Auslegerverlängerung • Extension treillis • Plumín fijo • Jib • удлинитель стрелы



49,69 m



25°
16,0 - 64,0 m



8,5 m



360°



135 t



EN 13000

m	16,00	22,00	28,00	34,00	40,00	46,00	52,00	58,00	64,00	m
16,0	26,0	-	-	-	-	-	-	-	-	16,0
18,0	25,0	-	-	-	-	-	-	-	-	18,0
20,0	23,0	19,2	-	-	-	-	-	-	-	20,0
22,0	21,5	18,6	-	-	-	-	-	-	-	22,0
24,0	20,0	17,4	13,7	-	-	9,3	-	-	-	24,0
26,0	18,5	16,4	13,4	-	-	9,3	-	-	-	26,0
28,0	16,9	15,4	13,1	9,7	-	9,1	7,0	-	-	28,0
30,0	15,4	14,4	12,6	9,4	7,3	8,7	7,0	-	-	30,0
32,0	14,1	13,5	11,9	9,2	7,3	8,4	6,9	5,4	-	32,0
34,0	13,0	12,5	11,3	9,0	7,1	8,0	6,6	5,4	-	34,0
36,0	11,8	11,6	10,7	8,8	6,9	7,7	6,3	5,3	4,2	36,0
38,0	10,7	10,8	10,2	8,5	6,7	7,4	6,1	5,1	4,2	38,0
40,0	9,9	9,9	9,6	8,3	6,6	7,0	5,8	4,9	4,2	40,0
42,0	9,1	9,1	9,0	8,0	6,4	6,6	5,6	4,7	4,0	42,0
44,0	8,3	8,3	8,4	7,7	6,2	6,2	5,3	4,5	3,8	44,0
46,0	7,5	7,7	7,8	7,4	6,1	5,9	5,1	4,3	3,6	46,0
48,0	6,9	7,1	7,2	7,0	5,9	5,5	4,8	4,1	3,5	48,0
50,0	6,3	6,5	6,6	6,5	5,8	5,1	4,6	3,9	3,3	50,0
52,0	5,7	5,9	6,1	6,1	5,6	4,8	4,3	3,7	3,2	52,0
54,0	5,2	5,4	5,6	5,7	5,3	4,4	4,1	3,6	3,0	54,0
56,0	4,7	4,9	5,1	5,2	5,0	4,1	3,8	3,4	2,9	56,0
58,0	4,2	4,4	4,6	4,8	4,8	3,8	3,5	3,2	2,7	58,0
60,0	-	4,0	4,2	4,4	4,5	3,4	3,3	3,0	2,6	60,0
62,0	-	3,6	3,8	4,0	4,1	3,1	3,0	2,8	2,4	62,0
64,0	-	-	3,4	3,5	3,8	2,8	2,8	2,6	2,2	64,0
66,0	-	-	3,0	3,2	3,4	2,4	2,5	2,4	2,1	66,0
68,0	-	-	2,7	2,8	3,0	2,1	2,2	2,2	1,9	68,0
70,0	-	-	-	2,5	2,7	1,8	1,9	2,0	1,7	70,0
72,0	-	-	-	2,2	2,4	-	1,6	1,7	-	72,0
74,0	-	-	-	1,8	2,1	-	-	-	-	74,0
76,0	-	-	-	-	1,8	-	-	-	-	76,0

Load charts • Traglasten • Capacités de levage Capacidades • Capacità • Таблицы грузоподъемности

Lattice extension • Auslegerverlängerung • Extension treillis • Plumín fijo • Jib • удлинитель стрелы



54,59 m



3°
12,0-64,0 m



8,5 m



360°



135 t



EN 13000

m	12,00	16,00	22,00	28,00	34,00	40,00	46,00	52,00	58,00	64,00	m
15,0	28,0	-	-	-	-	-	-	-	-	-	15,0
16,0	28,0	24,0	-	-	-	-	-	-	-	-	16,0
18,0	27,0	24,0	19,4	-	-	-	-	-	-	-	18,0
20,0	25,5	23,0	19,4	16,2	-	-	-	-	-	-	20,0
22,0	24,0	21,5	19,2	16,1	13,7	11,2	-	-	-	-	22,0
24,0	22,5	20,5	18,3	15,6	13,3	10,8	9,0	-	-	-	24,0
26,0	21,0	19,3	17,3	15,2	12,9	10,5	9,0	7,2	-	-	26,0
28,0	19,4	18,2	16,4	14,7	12,3	10,2	8,7	7,2	6,0	-	28,0
30,0	18,0	16,8	15,5	14,0	11,9	9,8	8,4	6,9	5,9	5,0	30,0
32,0	16,8	15,6	14,6	13,3	11,5	9,5	8,1	6,7	5,7	4,9	32,0
34,0	15,5	14,4	13,7	12,5	11,2	9,2	7,8	6,4	5,5	4,7	34,0
36,0	14,4	13,4	12,8	11,8	10,6	8,9	7,5	6,2	5,2	4,5	36,0
38,0	13,3	12,3	11,9	11,0	10,1	8,6	7,2	6,0	5,0	4,3	38,0
40,0	12,2	11,2	11,0	10,3	9,5	8,3	7,0	5,7	4,8	4,1	40,0
42,0	11,4	10,4	10,3	9,7	9,0	8,0	6,7	5,5	4,6	3,9	42,0
44,0	10,6	9,7	9,6	9,2	8,5	7,8	6,5	5,3	4,4	3,8	44,0
46,0	9,8	8,9	8,8	8,7	8,0	7,5	6,2	5,1	4,2	3,6	46,0
48,0	9,2	8,3	8,2	8,1	7,6	7,1	5,9	4,9	4,1	3,4	48,0
50,0	8,5	7,6	7,6	7,6	7,2	6,7	5,6	4,7	3,9	3,3	50,0
52,0	7,9	7,0	7,0	7,1	6,8	6,3	5,2	4,5	3,7	3,1	52,0
54,0	7,4	6,5	6,5	6,6	6,4	6,0	4,9	4,2	3,5	3,0	54,0
56,0	6,9	6,0	6,0	6,1	6,0	5,7	4,6	4,0	3,4	2,8	56,0
58,0	6,3	5,5	5,5	5,6	5,6	5,3	4,3	3,7	3,2	2,7	58,0
60,0	5,8	5,0	5,1	5,1	5,1	5,0	4,0	3,4	3,0	2,5	60,0
62,0	4,9	4,6	4,7	4,7	4,8	4,7	3,8	3,2	2,8	2,4	62,0
64,0	-	4,1	4,3	4,3	4,4	4,4	3,5	2,9	2,6	2,3	64,0
66,0	-	2,4	3,9	4,0	4,0	4,0	3,3	2,7	2,4	2,2	66,0
68,0	-	-	3,5	3,6	3,6	3,7	3,0	2,5	2,2	2,0	68,0
70,0	-	-	3,1	3,3	3,3	3,3	2,8	2,3	2,0	1,8	70,0
72,0	-	-	-	2,9	3,0	3,0	2,5	2,1	1,8	1,6	72,0
74,0	-	-	-	2,6	2,7	2,8	2,3	1,9	-	-	74,0
76,0	-	-	-	2,3	2,4	2,5	2,0	1,6	-	-	76,0
78,0	-	-	-	-	2,1	2,2	1,7	-	-	-	78,0
80,0	-	-	-	-	1,8	1,9	-	-	-	-	80,0
82,0	-	-	-	-	-	1,6	-	-	-	-	82,0



54,59 m



25°
16,0-64,0 m



8,5 m



360°



135 t



EN 13000

m	16,00	22,00	28,00	34,00	40,00	46,00	52,00	58,00	64,00	m
18,0	21,0	-	-	-	-	-	-	-	-	18,0
20,0	19,9	-	-	-	-	-	-	-	-	20,0
22,0	18,7	16,2	-	-	-	-	-	-	-	22,0
24,0	17,5	15,5	-	-	-	-	-	-	-	24,0
26,0	16,3	14,6	12,7	-	-	8,2	-	-	-	26,0
28,0	15,2	13,7	12,2	-	-	8,2	-	-	-	28,0
30,0	14,1	12,7	11,4	9,2	-	8,2	6,3	-	-	30,0
32,0	12,9	11,8	10,8	9,1	6,9	7,8	6,3	-	-	32,0
34,0	11,9	11,2	10,2	8,9	6,9	7,4	6,3	4,8	-	34,0
36,0	11,0	10,6	9,6	8,7	6,8	7,0	6,0	4,8	-	36,0
38,0	10,0	9,9	9,0	8,2	6,7	6,6	5,8	4,8	-	38,0
40,0	9,1	9,3	8,6	7,8	6,5	6,2	5,6	4,7	3,7	40,0
42,0	8,3	8,6	8,1	7,4	6,3	5,8	5,3	4,5	3,7	42,0
44,0	7,7	8,0	7,6	7,0	6,2	5,4	5,0	4,3	3,7	44,0
46,0	7,0	7,3	7,1	6,6	6,0	5,1	4,6	4,1	3,5	46,0
48,0	6,4	6,7	6,7	6,2	5,7	4,7	4,3	3,9	3,4	48,0
50,0	5,7	6,2	6,3	5,8	5,4	4,4	4,0	3,7	3,3	50,0
52,0	5,2	5,7	5,8	5,5	5,1	4,1	3,8	3,5	3,0	52,0
54,0	4,7	5,1	5,4	5,2	4,8	3,8	3,5	3,2	2,8	54,0
56,0	4,2	4,6	4,9	4,9	4,5	3,5	3,2	3,0	2,6	56,0
58,0	3,7	4,2	4,5	4,5	4,3	3,3	3,0	2,7	2,4	58,0
60,0	3,3	3,8	4,0	4,1	4,0	3,0	2,7	2,5	2,2	60,0
62,0	2,9	3,4	3,6	3,8	3,8	2,7	2,5	2,2	2,0	62,0
64,0	-	3,0	3,2	3,4	3,5	2,5	2,3	2,0	1,8	64,0
66,0	-	2,6	2,9	3,0	3,2	2,2	2,0	1,8	-	66,0
68,0	-	-	2,5	2,6	2,9	1,9	1,8	1,6	-	68,0
70,0	-	-	2,2	2,3	2,5	1,6	-	-	-	70,0
72,0	-	-	1,8	2,0	2,2	-	-	-	-	72,0
74,0	-	-	-	1,7	1,9	-	-	-	-	74,0
76,0	-	-	-	-	1,6	-	-	-	-	76,0

Load charts • Traglasten • Capacités de levage Capacidades • Capacità • Таблицы грузоподъемности

Lattice extension • Auslegerverlängerung • Extension treillis • Plumín fijo • Jib • удлинитель стрелы



36,00 m



12,0 - 36,0 m



8,5 m



360°

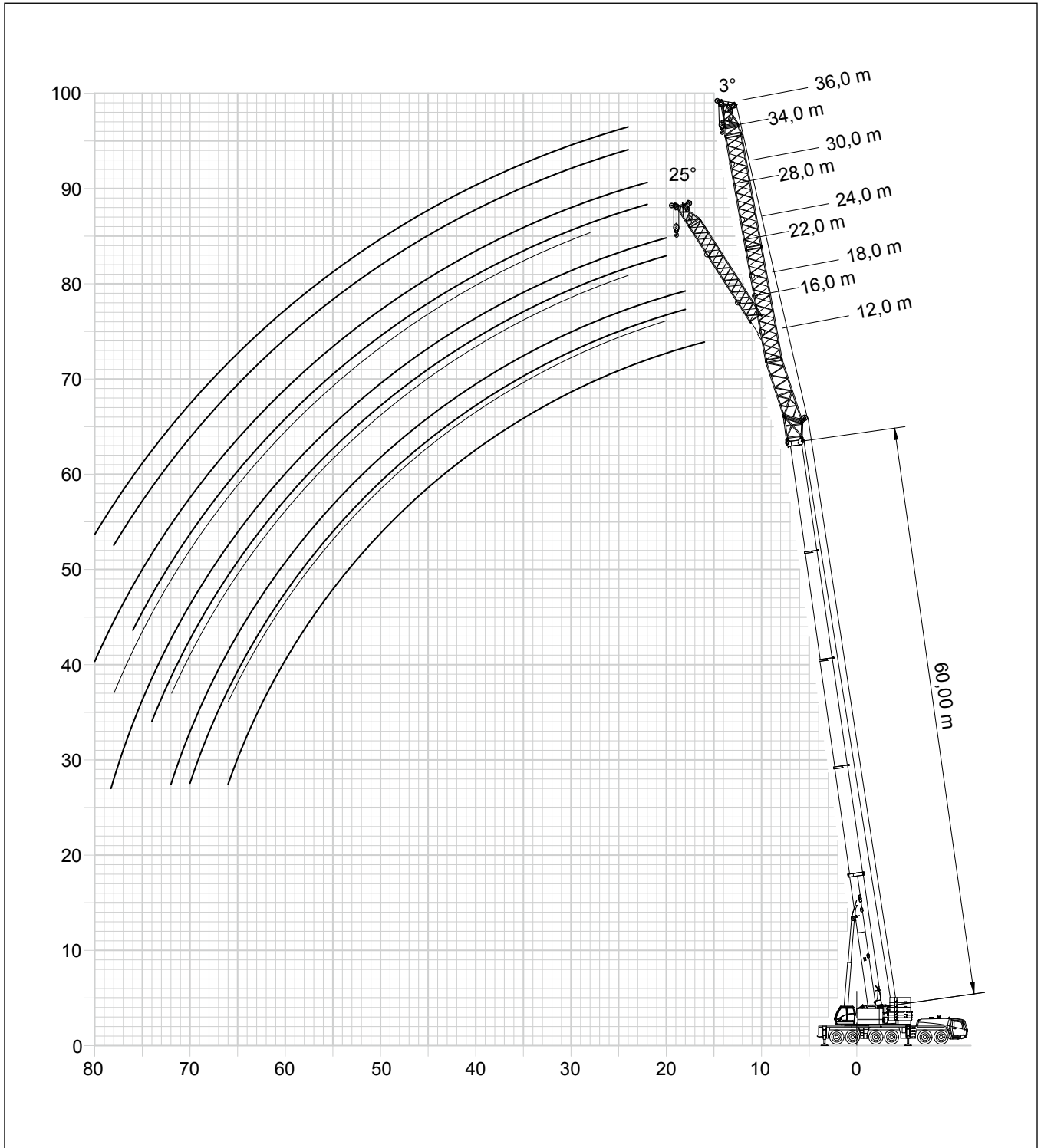

Load charts • Traglasten • Capacités de levage Capacidades • Capacità • Таблицы грузоподъемности

Lattice extension • Auslegerverlängerung • Extension treillis • Plumín fijo • Jib • удлинитель стрелы



60,00 m



3°
12,0 - 30,0 m



8,5 m



360°



135 t



EN 13000

m	12,00	16,00	16,00/25°	18,00	22,00	22,00/25°	24,00	28,00	28,00/25°	30,00	m
16,0	22,0	-	-	-	-	-	-	-	-	-	16,0
18,0	22,0	19,0	-	18,0	-	-	-	-	-	-	18,0
20,0	22,0	19,0	19,0	18,0	15,5	-	15,0	-	-	-	20,0
22,0	22,0	19,0	18,7	18,0	15,5	-	15,0	13,0	-	12,5	22,0
24,0	20,5	18,7	17,8	18,0	15,5	15,5	15,0	13,0	-	12,5	24,0
26,0	19,4	17,7	17,0	17,4	15,5	15,1	15,0	13,0	-	12,5	26,0
28,0	18,0	16,7	16,1	16,6	15,0	14,4	14,8	13,0	12,0	12,5	28,0
30,0	16,8	15,5	15,2	15,8	14,3	13,7	14,2	12,8	11,9	12,5	30,0
32,0	15,6	14,4	14,1	14,9	13,6	12,9	13,5	12,1	11,5	12,0	32,0
34,0	14,5	13,3	13,0	14,0	12,9	12,1	12,9	11,4	11,0	11,3	34,0
36,0	13,4	12,3	12,0	13,0	12,0	11,5	12,2	10,8	10,5	10,8	36,0
38,0	12,4	11,3	11,1	12,0	11,0	10,9	11,5	10,3	10,0	10,3	38,0
40,0	11,3	10,3	10,3	11,0	10,1	10,4	10,7	9,7	9,5	9,8	40,0
42,0	10,6	9,6	9,5	10,3	9,4	9,8	10,1	9,2	9,0	9,3	42,0
44,0	9,8	8,9	8,8	9,6	8,8	9,1	9,4	8,6	8,5	8,8	44,0
46,0	9,1	8,1	8,1	8,9	8,1	8,5	8,7	8,1	8,0	8,3	46,0
48,0	8,4	7,5	7,5	8,3	7,5	7,9	8,2	7,5	7,6	7,8	48,0
50,0	7,8	6,9	6,9	7,7	6,9	7,2	7,6	6,9	7,1	7,3	50,0
52,0	7,2	6,3	6,3	7,1	6,3	6,7	7,0	6,4	6,7	6,9	52,0
54,0	6,7	5,9	5,7	6,6	5,9	6,2	6,6	5,9	6,2	6,4	54,0
56,0	6,2	5,4	5,2	6,1	5,4	5,7	6,1	5,5	5,8	6,0	56,0
58,0	5,7	4,9	4,8	5,7	4,9	5,2	5,6	5,0	5,4	5,5	58,0
60,0	5,2	4,4	4,3	5,2	4,4	4,7	5,2	4,6	4,9	5,1	60,0
62,0	4,8	4,0	3,8	4,8	4,0	4,3	4,8	4,2	4,5	4,7	62,0
64,0	4,4	3,6	3,5	4,4	3,7	3,9	4,4	3,8	4,1	4,3	64,0
66,0	4,0	3,2	3,1	4,0	3,3	3,5	4,0	3,4	3,7	3,9	66,0
68,0	-	2,9	-	3,6	2,9	3,1	3,6	3,0	3,3	3,6	68,0
70,0	-	2,3	-	3,3	2,6	2,7	3,3	2,7	3,0	3,2	70,0
72,0	-	-	-	3,0	2,3	2,4	3,0	2,4	2,6	2,9	72,0
74,0	-	-	-	-	2,0	-	2,7	2,1	2,3	2,6	74,0
76,0	-	-	-	-	-	-	2,4	1,8	2,0	2,3	76,0
78,0	-	-	-	-	-	-	2,1	-	1,7	2,1	78,0
80,0	-	-	-	-	-	-	-	-	-	1,8	80,0

Load charts • Traglasten • Capacités de levage Capacidades • Capacità • Таблицы грузоподъемности

MEGAWINGLIFT

Lattice extension • Auslegerverlängerung • Extension treillis • Plumín fijo • Jib • удлинитель стрелы



34,99 - 54,59 m



64 m



8,5 m



360°



135 t

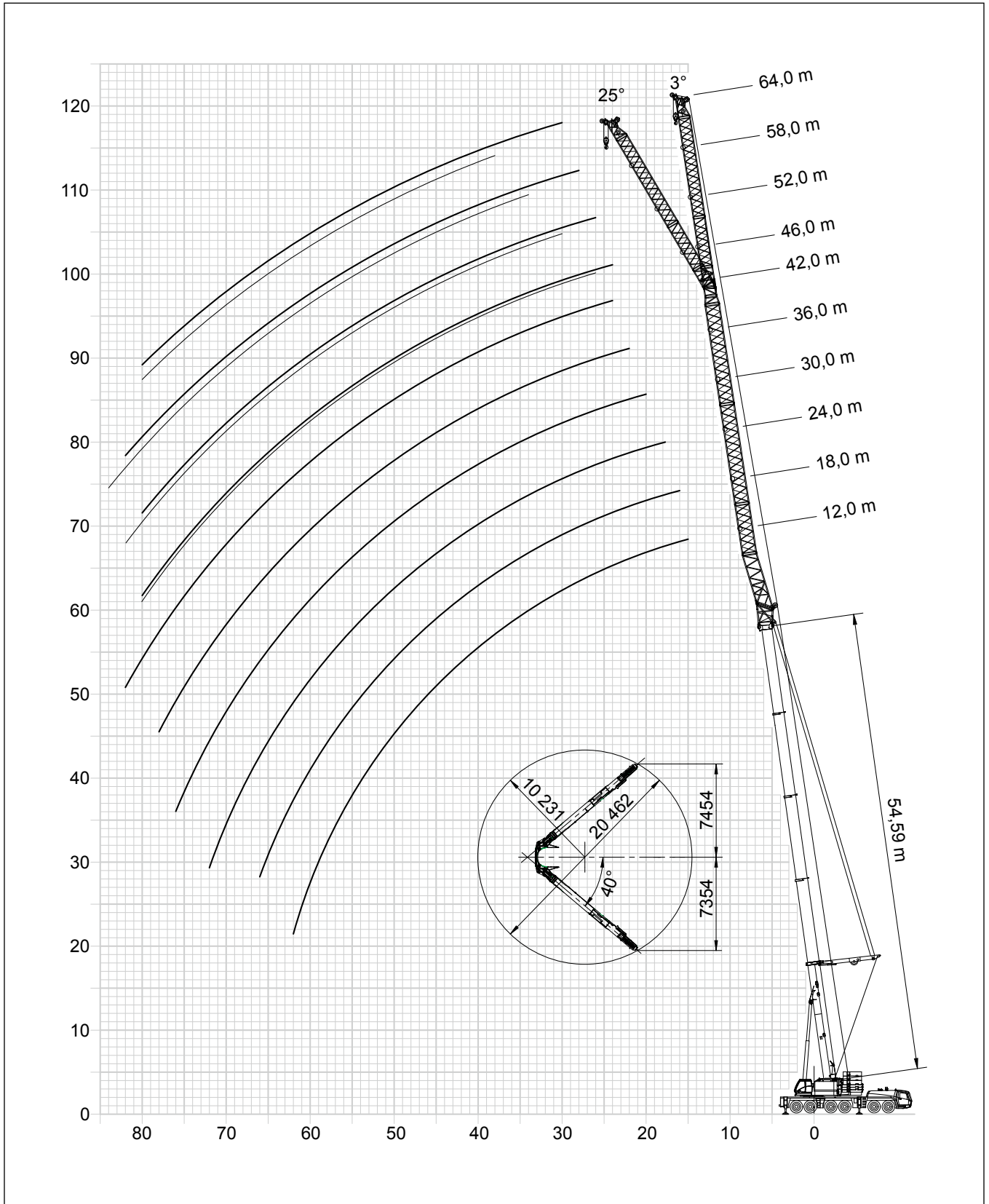

Load charts • Traglasten • Capacités de levage Capacidades • Capacità • Таблицы грузоподъемности

MEGAWINGLIFT

Lattice extension • Auslegerverlängerung • Extension treillis • Plumín fijo • Jib • удлинитель стрелы



49,69 m



3°
12 - 64 m



8,5 m



360°



135 t



EN 13000

m	12,00	16,00	22,00	28,00	34,00	40,00	46,00	52,00	58,00	64,00	m
13,0	59,5	-	-	-	-	-	-	-	-	-	13,0
14,0	57,0	48,5	-	-	-	-	-	-	-	-	14,0
15,0	54,5	47,5	-	-	-	-	-	-	-	-	15,0
16,0	52,5	46,5	33,5	-	-	-	-	-	-	-	16,0
18,0	48,5	44,0	32,0	24,0	-	-	-	-	-	-	18,0
20,0	44,5	41,0	30,5	23,0	18,6	-	-	-	-	-	20,0
22,0	41,0	38,5	29,0	22,0	17,7	14,9	13,1	-	-	-	22,0
24,0	38,0	35,5	28,0	21,0	16,8	14,1	12,0	10,4	-	-	24,0
26,0	34,5	33,0	26,5	19,8	16,1	13,3	11,3	9,7	8,5	-	26,0
28,0	31,0	30,5	25,5	19,0	15,3	12,6	10,7	9,2	8,1	6,8	28,0
30,0	27,5	27,5	24,5	18,3	14,6	11,8	10,1	8,7	7,6	6,6	30,0
32,0	25,0	25,0	23,5	17,5	13,9	11,1	9,6	8,3	7,2	6,3	32,0
34,0	22,5	22,5	22,5	16,8	13,2	10,7	9,0	7,8	6,8	5,9	34,0
36,0	20,5	20,0	21,0	16,2	12,5	10,2	8,6	7,4	6,5	5,6	36,0
38,0	18,5	18,3	19,1	15,7	11,9	9,8	8,3	7,1	6,1	5,3	38,0
40,0	16,7	16,5	17,4	15,1	11,5	9,4	7,9	6,7	5,8	5,0	40,0
42,0	15,2	15,0	15,9	14,6	11,1	9,0	7,5	6,4	5,5	4,7	42,0
44,0	13,8	13,6	14,4	14,1	10,7	8,7	7,1	6,1	5,2	4,5	44,0
46,0	12,5	12,3	13,1	13,6	10,3	8,4	6,9	5,8	4,9	4,3	46,0
48,0	11,4	11,1	12,0	12,7	9,9	8,1	6,6	5,6	4,7	4,0	48,0
50,0	9,9	10,0	10,9	11,7	9,6	7,8	6,3	5,3	4,4	3,8	50,0
52,0	8,1	8,7	9,8	10,7	9,4	7,5	6,0	5,1	4,2	3,6	52,0
54,0	6,2	7,2	8,8	9,7	9,1	7,3	5,8	4,9	4,0	3,4	54,0
56,0	5,3	5,5	7,8	8,7	8,8	7,0	5,5	4,6	3,8	3,2	56,0
58,0	2,0	3,7	6,6	7,8	8,4	6,8	5,3	4,4	3,6	3,1	58,0
60,0	-	2,7	5,3	7,0	7,5	6,6	5,1	4,2	3,4	2,9	60,0
62,0	-	-	3,9	6,2	6,7	6,4	4,8	4,0	3,2	2,7	62,0
64,0	-	-	3,1	5,0	6,0	6,2	4,6	3,8	3,1	2,6	64,0
66,0	-	-	-	3,9	5,3	5,8	4,4	3,6	2,9	2,4	66,0
68,0	-	-	-	2,6	4,5	5,1	4,2	3,5	2,8	2,3	68,0
70,0	-	-	-	1,9	3,5	4,5	4,0	3,3	2,6	2,1	70,0
72,0	-	-	-	-	2,5	3,9	3,7	3,1	2,5	2,0	72,0
74,0	-	-	-	-	-	3,1	3,1	2,9	2,4	1,9	74,0
76,0	-	-	-	-	-	2,2	2,6	2,8	2,2	1,7	76,0
78,0	-	-	-	-	-	-	2,0	2,5	2,1	1,6	78,0
80,0	-	-	-	-	-	-	-	2,0	2,0	-	80,0
82,0	-	-	-	-	-	-	-	-	1,9	-	82,0

Load charts • Traglasten • Capacités de levage Capacidades • Capacità • Таблицы грузоподъемности

MEGAWINGLIFT

Lattice extension • Auslegerverlängerung • Extension treillis • Plumín fijo • Jib • удлинитель стрелы



49,69 m



25°
16 - 64 m



8,5 m



360°



135 t



EN 13000

m	16,00	22,00	28,00	34,00	40,00	46,00	52,00	58,00	64,00	m
16,0	39,5	-	-	-	-	-	-	-	-	16,0
18,0	38,5	-	-	-	-	-	-	-	-	18,0
20,0	37,0	21,5	-	-	-	-	-	-	-	20,0
22,0	35,5	21,0	-	-	-	-	-	-	-	22,0
24,0	34,0	20,5	14,5	-	-	11,4	-	-	-	24,0
26,0	32,0	19,8	14,1	-	-	10,8	-	-	-	26,0
28,0	30,5	19,4	13,8	10,1	-	10,3	8,4	-	-	28,0
30,0	28,5	18,9	13,4	9,9	7,9	9,7	8,0	-	-	30,0
32,0	25,5	18,5	13,0	9,6	7,7	9,3	7,6	6,4	-	32,0
34,0	23,0	18,1	12,6	9,3	7,5	8,8	7,3	6,2	-	34,0
36,0	20,5	17,7	12,1	9,1	7,2	8,3	6,9	5,9	4,9	36,0
38,0	18,8	17,4	11,7	8,9	7,0	8,0	6,6	5,6	4,7	38,0
40,0	17,0	17,0	11,5	8,7	6,8	7,6	6,3	5,3	4,5	40,0
42,0	15,4	16,7	11,3	8,5	6,7	7,3	6,0	5,1	4,3	42,0
44,0	14,0	15,4	11,0	8,3	6,5	7,0	5,8	4,9	4,1	44,0
46,0	12,6	14,1	10,8	8,1	6,3	6,7	5,5	4,6	3,9	46,0
48,0	11,4	12,8	10,6	7,9	6,1	6,4	5,3	4,4	3,7	48,0
50,0	10,3	11,6	10,5	7,8	6,0	6,2	5,1	4,3	3,5	50,0
52,0	9,1	10,6	10,3	7,6	5,9	5,9	4,9	4,1	3,3	52,0
54,0	7,6	9,6	10,2	7,5	5,8	5,7	4,7	3,9	3,2	54,0
56,0	5,9	8,5	9,7	7,3	5,6	5,4	4,5	3,7	3,0	56,0
58,0	4,0	7,5	8,8	7,2	5,5	5,2	4,3	3,5	2,9	58,0
60,0	-	6,2	7,8	7,1	5,4	5,0	4,1	3,4	2,7	60,0
62,0	-	4,7	6,9	7,0	5,3	4,8	3,9	3,2	2,6	62,0
64,0	-	-	6,1	6,9	5,2	4,6	3,7	3,1	2,5	64,0
66,0	-	-	5,0	6,4	5,1	4,3	3,6	2,9	2,3	66,0
68,0	-	-	3,7	5,6	5,0	4,1	3,4	2,8	2,2	68,0
70,0	-	-	-	4,9	5,0	4,0	3,2	2,7	2,1	70,0
72,0	-	-	-	3,9	4,9	3,8	3,1	2,5	2,0	72,0
74,0	-	-	-	2,7	4,4	3,5	2,9	2,4	1,8	74,0
76,0	-	-	-	-	3,8	2,9	2,8	2,3	1,7	76,0
78,0	-	-	-	-	2,9	2,4	2,6	2,1	1,6	78,0
80,0	-	-	-	-	1,8	1,6	2,4	2,0	-	80,0
82,0	-	-	-	-	-	-	1,9	1,9	-	82,0
84,0	-	-	-	-	-	-	-	1,8	-	84,0

Load charts • Traglasten • Capacités de levage Capacidades • Capacità • Таблицы грузоподъемности

MEGAWINGLIFT

Lattice extension • Auslegerverlängerung • Extension treillis • Plumín fijo • Jib • удлинитель стрелы



54,59 m



3°
12 - 64 m



8,5 m



360°



135 t



EN 13000

m	12,00	16,00	22,00	28,00	34,00	40,00	46,00	52,00	58,00	64,00	m
15,0	49,5	-	-	-	-	-	-	-	-	-	15,0
16,0	47,5	43,5	-	-	-	-	-	-	-	-	16,0
18,0	44,0	40,5	31,5	-	-	-	-	-	-	-	18,0
20,0	41,0	37,5	30,0	22,5	-	-	-	-	-	-	20,0
22,0	37,5	35,0	29,0	21,5	17,5	14,5	-	-	-	-	22,0
24,0	35,5	32,5	27,5	20,5	16,7	13,9	11,5	-	-	-	24,0
26,0	33,0	30,5	26,5	19,7	15,9	13,2	11,1	9,5	-	-	26,0
28,0	31,0	28,5	25,5	18,9	15,3	12,6	10,5	9,1	7,9	-	28,0
30,0	28,0	26,5	24,0	18,1	14,6	12,0	10,0	8,7	7,6	6,3	30,0
32,0	25,5	25,0	23,0	17,5	14,0	11,3	9,6	8,2	7,2	6,2	32,0
34,0	23,0	22,5	21,5	16,9	13,4	10,7	9,1	7,8	6,8	5,9	34,0
36,0	21,0	20,5	20,5	16,2	12,8	10,3	8,7	7,5	6,5	5,6	36,0
38,0	19,0	18,6	19,4	15,7	12,2	9,9	8,3	7,1	6,2	5,3	38,0
40,0	17,2	16,9	17,6	15,2	11,6	9,6	8,0	6,8	5,8	5,0	40,0
42,0	15,7	15,3	16,1	14,8	11,2	9,2	7,6	6,5	5,5	4,8	42,0
44,0	14,3	13,9	14,6	14,3	10,9	8,9	7,3	6,2	5,2	4,5	44,0
46,0	13,0	12,6	13,4	13,8	10,5	8,6	7,0	5,9	5,0	4,3	46,0
48,0	11,8	11,4	12,2	12,9	10,2	8,3	6,7	5,7	4,8	4,1	48,0
50,0	10,8	10,3	11,1	11,8	9,8	8,0	6,4	5,4	4,5	3,9	50,0
52,0	9,7	9,2	10,1	10,8	9,6	7,7	6,2	5,2	4,3	3,7	52,0
54,0	8,4	8,2	9,1	9,9	9,3	7,4	5,9	5,0	4,0	3,5	54,0
56,0	6,9	7,2	8,1	8,9	9,1	7,2	5,7	4,8	3,9	3,3	56,0
58,0	5,2	5,8	7,2	8,0	8,5	7,0	5,4	4,6	3,7	3,1	58,0
60,0	4,3	4,4	6,3	7,2	7,6	6,8	5,2	4,4	3,5	3,0	60,0
62,0	2,2	2,9	5,4	6,4	6,8	6,6	5,0	4,1	3,4	2,8	62,0
64,0	-	2,3	4,2	5,6	6,1	6,4	4,8	4,0	3,2	2,7	64,0
66,0	-	-	3,0	4,9	5,4	5,8	4,6	3,8	3,0	2,5	66,0
68,0	-	-	1,6	3,9	4,7	5,2	4,4	3,6	2,9	2,4	68,0
70,0	-	-	-	2,9	4,1	4,5	4,2	3,5	2,8	2,2	70,0
72,0	-	-	-	1,8	3,4	3,9	3,8	3,3	2,6	2,1	72,0
74,0	-	-	-	1,7	2,5	3,4	3,3	3,1	2,5	2,0	74,0
76,0	-	-	-	-	1,6	2,9	2,7	3,0	2,4	1,9	76,0
78,0	-	-	-	-	-	2,2	2,2	2,5	2,3	1,7	78,0
80,0	-	-	-	-	-	-	1,8	2,0	2,1	1,6	80,0
82,0	-	-	-	-	-	-	-	-	1,8	-	82,0

Load charts • Traglasten • Capacités de levage Capacidades • Capacità • Таблицы грузоподъемности

MEGAWINGLIFT

Lattice extension • Auslegerverlängerung • Extension treillis • Plumín fijo • Jib • удлинитель стрелы



54,59 m



25°
16 - 64 m



8,5 m



360°



135 t



EN 13000

m	16,00	22,00	28,00	34,00	40,00	46,00	52,00	58,00	64,00	m
18,0	37,0	-	-	-	-	-	-	-	-	18,0
20,0	35,0	-	-	-	-	-	-	-	-	20,0
22,0	33,5	21,0	-	-	-	-	-	-	-	22,0
24,0	31,5	20,5	-	-	-	-	-	-	-	24,0
26,0	29,5	19,9	14,1	-	-	10,6	-	-	-	26,0
28,0	28,0	19,4	13,6	-	-	10,1	-	-	-	28,0
30,0	26,0	18,9	13,3	9,8	-	9,6	8,0	-	-	30,0
32,0	24,5	18,5	13,0	9,6	7,7	9,2	7,6	-	-	32,0
34,0	23,0	18,2	12,6	9,4	7,4	8,8	7,3	6,0	-	34,0
36,0	21,0	17,8	12,2	9,1	7,2	8,4	6,9	5,9	-	36,0
38,0	19,2	17,3	11,8	8,9	7,0	8,0	6,7	5,6	4,6	38,0
40,0	17,4	16,8	11,4	8,7	6,8	7,7	6,4	5,3	4,5	40,0
42,0	15,9	16,3	11,1	8,5	6,7	7,4	6,1	5,1	4,3	42,0
44,0	14,4	15,7	11,0	8,3	6,5	7,1	5,8	4,9	4,1	44,0
46,0	13,1	14,3	10,8	8,1	6,4	6,8	5,6	4,7	3,9	46,0
48,0	11,9	13,1	10,6	8,0	6,2	6,5	5,4	4,5	3,7	48,0
50,0	10,8	11,9	10,4	7,8	6,0	6,3	5,2	4,3	3,5	50,0
52,0	9,7	10,9	10,2	7,7	5,9	6,1	4,9	4,1	3,4	52,0
54,0	8,6	9,9	10,1	7,5	5,8	5,8	4,7	4,0	3,2	54,0
56,0	7,6	8,9	9,9	7,4	5,7	5,6	4,6	3,8	3,1	56,0
58,0	6,3	7,9	9,0	7,3	5,6	5,4	4,4	3,6	2,9	58,0
60,0	4,9	7,0	8,1	7,2	5,4	5,1	4,2	3,5	2,8	60,0
62,0	3,3	6,1	7,2	7,1	5,4	5,0	4,0	3,3	2,6	62,0
64,0	-	5,0	6,4	7,0	5,3	4,8	3,9	3,2	2,5	64,0
66,0	-	3,8	5,6	6,6	5,2	4,6	3,7	3,0	2,4	66,0
68,0	-	-	4,9	5,9	5,1	4,4	3,5	2,9	2,3	68,0
70,0	-	-	3,9	5,1	5,0	4,2	3,4	2,8	2,2	70,0
72,0	-	-	2,8	4,4	4,9	4,0	3,2	2,6	2,0	72,0
74,0	-	-	-	3,8	4,6	3,5	3,1	2,5	1,9	74,0
76,0	-	-	-	2,9	4,0	2,9	2,8	2,4	1,8	76,0
78,0	-	-	-	1,9	3,4	2,4	2,6	2,3	1,7	78,0
80,0	-	-	-	-	2,8	1,9	2,4	2,1	1,6	80,0
82,0	-	-	-	-	2,0	-	1,9	2,0	-	82,0
84,0	-	-	-	-	-	-	-	1,9	-	84,0

Load charts • Traglasten • Capacités de levage Capacidades • Capacità • Таблицы грузоподъемности

MEGAWINGLIFT

Lattice extension • Auslegerverlängerung • Extension treillis • Plumín fijo • Jib • удлинитель стрелы



60° - 70° - 80°
49,69 m



25 - 73 m



8,5 m



360°



135 t

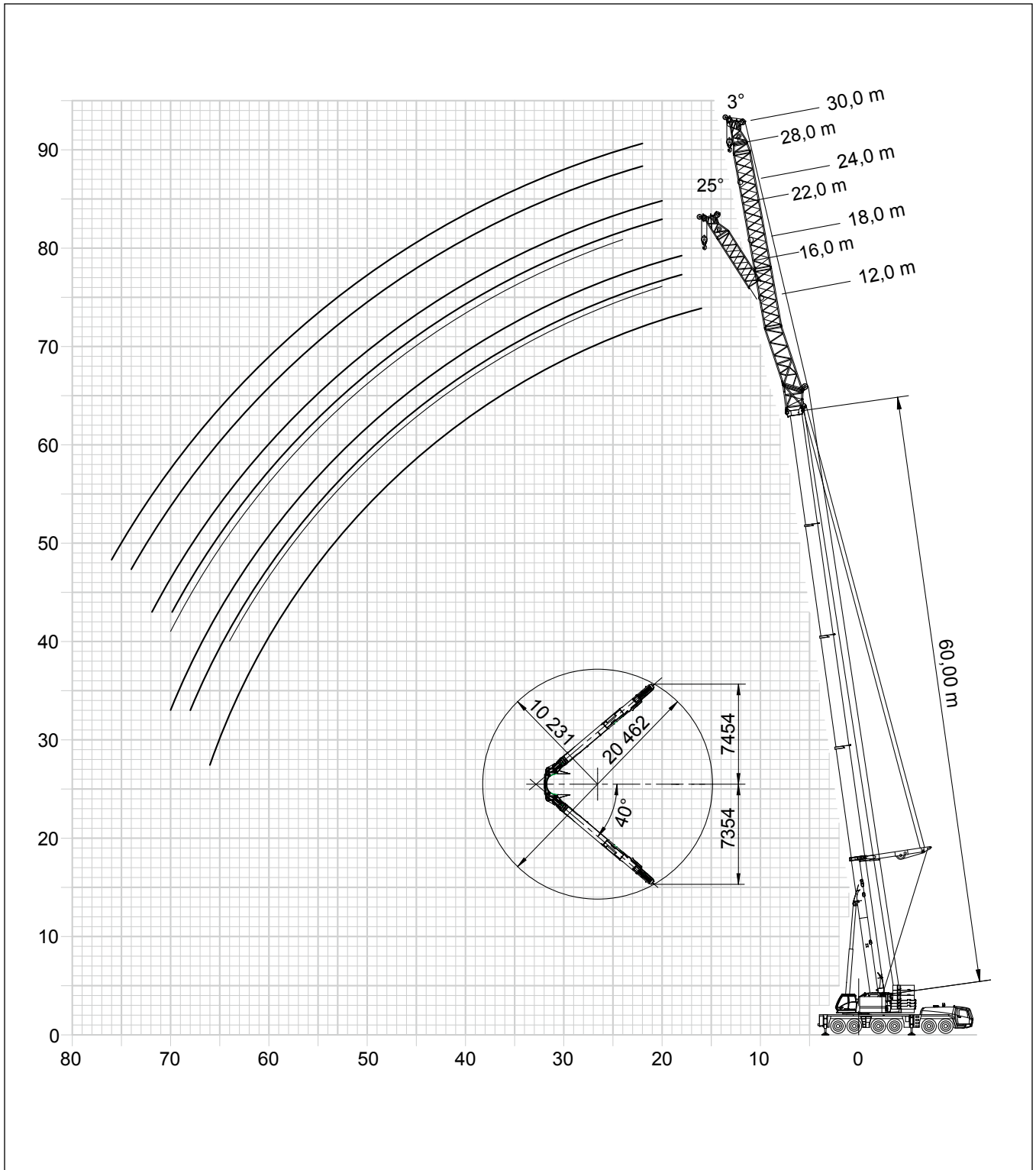

Load charts • Traglasten • Capacités de levage Capacidades • Capacità • Таблицы грузоподъемности

MEGAWINGLIFT

Lattice extension • Auslegerverlängerung • Extension treillis • Plumín fijo • Jib • удлинитель стрелы



60,00 m



3°
12 - 30 m



8,5 m



360°



135 t



EN 13000

m	12,00	16,00	16,00/25°	18,00	22,00	22,00/25°	24,00	28,00	28,00/25°	30,00	m
16,0	43,5	-	-	-	-	-	-	-	-	-	16,0
18,0	41,0	35,5	-	33,5	-	-	-	-	-	-	18,0
20,0	38,5	33,5	30,5	32,0	28,0	-	27,0	-	-	-	20,0
22,0	36,0	31,5	29,0	30,0	26,5	-	25,5	21,5	-	21,5	22,0
24,0	34,0	30,0	27,5	28,5	25,0	20,5	24,0	20,5	-	20,5	24,0
26,0	32,0	28,0	26,0	27,0	24,0	19,8	23,0	19,8	14,1	19,6	26,0
28,0	30,0	27,0	25,0	25,5	22,5	19,3	22,0	19,1	13,6	18,8	28,0
30,0	28,0	25,5	24,0	24,5	21,5	18,8	20,5	18,3	13,3	17,9	30,0
32,0	25,5	24,0	23,0	23,5	20,5	18,2	19,9	17,6	13,0	17,1	32,0
34,0	23,0	22,5	22,0	22,0	19,6	17,5	19,0	16,9	12,6	16,4	34,0
36,0	21,0	20,5	21,0	21,0	18,6	16,9	18,2	16,2	12,2	15,7	36,0
38,0	18,9	18,6	19,1	19,6	17,9	16,2	17,4	15,5	11,8	15,1	38,0
40,0	17,2	16,9	17,4	17,9	17,2	15,7	16,8	14,8	11,4	14,4	40,0
42,0	15,6	15,3	15,8	16,3	15,9	15,2	16,2	14,2	11,1	13,8	42,0
44,0	14,2	13,9	14,3	14,9	14,5	14,7	15,6	13,7	11,0	13,3	44,0
46,0	12,9	12,6	13,0	13,6	13,2	14,2	14,3	13,1	10,8	12,8	46,0
48,0	11,8	11,5	11,8	12,4	12,0	13,0	13,1	12,5	10,6	12,3	48,0
50,0	10,7	10,3	10,7	11,4	10,9	11,8	12,0	11,6	10,4	11,7	50,0
52,0	9,6	9,2	9,6	10,4	9,9	10,8	11,0	10,6	10,2	11,3	52,0
54,0	8,6	8,2	8,5	9,4	8,8	9,8	10,1	9,6	10,1	10,4	54,0
56,0	7,6	7,2	7,5	8,4	7,9	8,8	9,2	8,7	9,9	9,5	56,0
58,0	6,7	6,3	6,6	7,5	7,0	7,8	8,3	7,7	9,0	8,6	58,0
60,0	5,4	5,5	5,7	6,7	6,1	6,9	7,4	6,9	8,1	7,8	60,0
62,0	4,0	4,4	4,8	5,9	5,3	6,0	6,6	6,1	7,2	7,0	62,0
64,0	2,5	3,2	3,5	4,9	4,6	5,2	5,9	5,3	6,4	6,2	64,0
66,0	2,0	1,9	2,2	3,8	3,9	4,5	5,2	4,6	5,6	5,5	66,0
68,0	-	1,7	-	2,6	2,9	3,6	4,5	4,0	4,9	4,9	68,0
70,0	-	-	-	2,0	1,8	2,6	3,6	3,4	3,9	4,3	70,0
72,0	-	-	-	-	-	-	2,6	2,6	2,8	3,7	72,0
74,0	-	-	-	-	-	-	-	1,7	-	3,0	74,0
76,0	-	-	-	-	-	-	-	-	-	2,2	76,0

Load charts • Traglasten • Capacités de levage Capacidades • Capacità • Таблицы грузоподъемности

Luffing jib • Wippspitzenausleger • Volée variable • Plumín de angulación variable • Jib a volata variable • Маневровый гусек



60° - 70° - 80°
49,69 m



25 - 73 m



8,5 m



360°



135 t

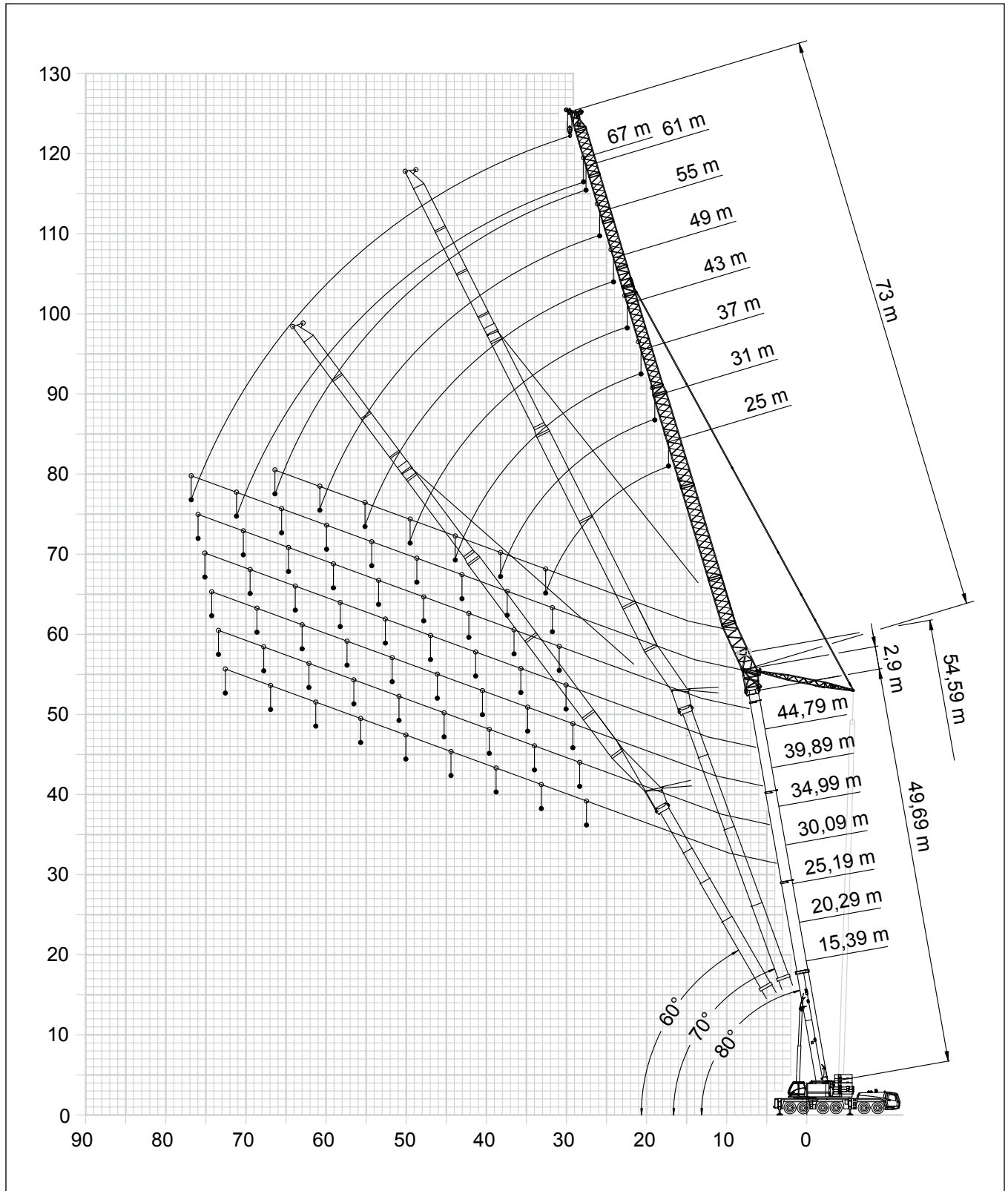

Load charts • Traglasten • Capacités de levage Capacidades • Capacità • Таблицы грузоподъемности

Luffing jib • Wippspitzenausleger • Volée variable • Plumín de angulación variable • Jib a volata variable • Маневровый гусек



80°
15,39 m



0-22°
25 - 73 m



8,5 m



360°



135 t



EN 13000

m	31,00		37,00		43,00		49,00		55,00		61,00		67,00		73,00		m
	0°	0°	0°	0°	0°	22°	0°	22°	0°	22°	0°	22°	0°	22°			
20,0	-	-	30,5	25,5	-	-	-	-	-	-	-	-	-	-	-	-	20,0
22,0	-	37,0	30,5	25,5	21,0	-	-	-	-	-	-	-	-	-	-	-	22,0
24,0	41,0	36,0	30,5	25,5	21,0	21,0	17,5	-	-	-	-	-	-	-	-	-	24,0
26,0	39,0	35,0	30,0	25,0	21,0	21,0	17,5	-	-	14,8	-	-	-	-	-	-	26,0
28,0	37,5	34,0	30,0	25,0	21,0	21,0	17,5	17,6	14,8	-	-	12,3	-	-	-	-	28,0
30,0	32,5	33,0	29,5	24,5	20,5	21,0	17,5	17,6	14,8	-	-	12,3	-	-	-	-	30,0
32,0	25,5	32,0	29,0	24,5	20,5	20,5	17,5	17,6	14,8	13,2	12,3	-	-	-	-	-	32,0
34,0	-	29,5	28,0	24,5	20,5	20,5	17,5	17,5	14,8	12,8	12,3	-	-	-	-	-	34,0
36,0	-	25,5	27,0	24,0	20,5	20,5	17,4	17,3	14,8	12,5	12,3	9,5	-	-	-	-	36,0
38,0	-	20,5	26,5	23,5	20,0	20,5	17,3	17,2	14,8	12,2	12,0	9,3	-	-	-	-	38,0
40,0	-	-	23,5	23,0	19,9	20,0	17,3	17,1	14,8	12,0	11,6	9,1	-	-	-	-	40,0
42,0	-	-	20,5	22,5	19,7	19,9	17,2	17,0	14,5	11,8	11,2	8,9	-	-	-	-	42,0
44,0	-	-	-	21,5	19,5	19,7	17,1	16,9	14,2	11,6	10,9	8,7	-	-	-	-	44,0
46,0	-	-	-	19,2	19,2	19,4	17,0	16,8	13,9	11,4	10,6	8,5	-	-	-	-	46,0
48,0	-	-	-	16,6	18,9	19,0	16,9	16,8	13,5	11,2	10,3	8,3	-	-	-	-	48,0
50,0	-	-	-	-	17,7	17,8	16,7	16,7	13,1	11,0	10,0	8,2	-	-	-	-	50,0
52,0	-	-	-	-	15,7	15,8	16,4	16,5	12,7	10,9	9,7	8,0	-	-	-	-	52,0
54,0	-	-	-	-	13,6	-	16,1	16,3	12,3	10,8	9,4	7,9	-	-	-	-	54,0
56,0	-	-	-	-	-	-	14,5	15,0	12,0	10,7	9,1	7,7	-	-	-	-	56,0
58,0	-	-	-	-	-	-	12,9	13,3	11,7	10,6	8,9	7,6	-	-	-	-	58,0
60,0	-	-	-	-	-	-	11,2	-	11,4	10,5	8,6	7,5	-	-	-	-	60,0
62,0	-	-	-	-	-	-	-	-	11,2	10,5	8,4	7,5	-	-	-	-	62,0
64,0	-	-	-	-	-	-	-	-	10,7	10,5	8,2	7,4	-	-	-	-	64,0
66,0	-	-	-	-	-	-	-	-	9,3	-	8,0	7,3	-	-	-	-	66,0
68,0	-	-	-	-	-	-	-	-	-	-	7,8	7,3	-	-	-	-	68,0
70,0	-	-	-	-	-	-	-	-	-	-	7,6	7,3	-	-	-	-	70,0
72,0	-	-	-	-	-	-	-	-	-	-	7,4	-	-	-	-	-	72,0



80°
25,19 m



0-22°
25 - 73 m



8,5 m



360°



135 t



EN 13000

m	25,00		31,00		37,00		43,00		49,00		55,00		61,00		67,00		73,00		m
	0°	0°	0°	0°	0°	22°	0°	22°	0°	22°	0°	22°	0°	22°	0°	22°			
15,0	50,5	-	-	-	-	-	-	-	-	-	-	-	-	-	-	-	-	-	15,0
16,0	50,5	39,5	32,5	-	-	-	-	-	-	-	-	-	-	-	-	-	-	-	16,0
18,0	50,0	39,5	32,5	26,5	-	-	-	-	-	-	-	-	-	-	-	-	-	-	18,0
20,0	47,0	39,5	32,5	26,5	-	-	-	-	-	-	-	-	-	-	-	-	-	-	20,0
22,0	44,5	39,5	32,5	26,5	21,5	-	-	-	-	-	-	-	-	-	-	-	-	-	22,0
24,0	42,5	39,5	32,5	26,5	21,5	18,0	-	-	-	-	-	-	-	-	-	-	-	-	24,0
26,0	40,5	39,5	32,5	26,5	21,5	18,0	18,2	15,1	-	-	-	-	-	-	-	-	-	-	26,0
28,0	34,5	39,5	32,5	26,5	21,5	18,0	18,2	15,1	-	12,8	-	-	-	-	-	-	-	-	28,0
30,0	-	36,5	32,5	26,5	21,5	18,0	18,2	15,1	15,3	12,8	-	10,6	-	-	-	-	-	-	30,0
32,0	-	34,0	32,5	26,5	21,5	18,0	18,2	15,1	15,3	12,8	-	10,6	-	-	-	-	-	-	32,0
34,0	-	27,5	31,5	26,5	21,5	18,0	18,2	15,1	15,3	12,8	12,7	10,6	-	-	-	-	-	-	34,0
36,0	-	-	29,5	26,5	21,5	18,0	18,2	15,1	15,3	12,8	12,4	10,6	-	-	-	-	-	-	36,0
38,0	-	-	27,5	26,5	21,5	18,0	18,2	15,1	15,3	12,8	12,1	10,6	9,3	-	-	-	-	-	38,0
40,0	-	-	22,0	25,5	21,5	18,0	18,2	15,1	15,3	12,8	11,8	10,6	9,1	-	-	-	-	-	40,0
42,0	-	-	-	24,0	21,5	18,0	18,2	15,1	15,3	12,8	11,7	10,6	8,9	-	-	-	-	-	42,0
44,0	-	-	-	22,0	21,5	18,0	18,2	15,1	15,3	12,8	11,5	10,6	8,7	-	-	-	-	-	44,0
46,0	-	-	-	-	21,5	18,0	18,2	15,1	15,3	12,8	11,3	10,5	8,6	-	-	-	-	-	46,0
48,0	-	-	-	-	20,5	18,0	18,2	15,1	15,3	12,8	11,2	10,3	8,4	-	-	-	-	-	48,0
50,0	-	-	-	-	18,3	18,0	18,2	15,1	15,3	12,8	11,0	10,0	8,2	-	-	-	-	-	50,0
52,0	-	-	-	-	-	17,9	17,9	15,1	15,3	12,7	10,9	9,8	8,1	-	-	-	-	-	52,0
54,0	-	-	-	-	-	17,1	17,1	15,1	15,3	12,3	10,8	9,5	7,9	-	-	-	-	-	54,0
56,0	-	-	-	-	-	15,0	-	15,1	15,3	12,0	10,7	9,3	7,8	-	-	-	-	-	56,0
58,0	-	-	-	-	-	-	-	15,1	15,3	11,8	10,6	9,0	7,7	-	-	-	-	-	58,0
60,0	-	-	-	-	-	-	-	14,3	14,7	11,6	10,5	8,8	7,6	-	-	-	-	-	60,0
62,0	-	-	-	-	-	-	-	12,4	-	11,3	10,5	8,6	7,5	-	-	-	-	-	62,0
64,0	-	-	-	-	-	-	-	-	-	11,1	10,4	8,3	7,4	-	-	-	-	-	64,0
66,0	-	-	-	-	-	-	-	-	-	10,9	10,4	8,1	7,4	-	-	-	-	-	66,0
68,0	-	-	-	-	-	-	-	-	-	10,3	-	7,9	7,3	-	-	-	-	-	68,0
70,0	-	-	-	-	-	-	-	-	-	-	-	7,7	7,3	-	-	-	-	-	70,0
72,0	-	-	-	-	-	-	-	-	-	-	-	7,6	7,3	-	-	-	-	-	72,0
74,0	-	-	-	-	-	-	-	-	-	-	-	7,4	-	-	-	-	-	-	74,0

Load charts • Traglasten • Capacités de levage Capacidades • Capacità • Таблицы грузоподъемности

Luffing jib • Wippspitzenausleger • Volée variable • Plumín de angulación variable • Jib a volata variable • Маневровый гусек



80°
34,99 m



0-22°
25 - 73 m



8,5 m



360°



135 t



EN 13000

m	25,00		31,00		37,00		43,00		49,00		55,00		61,00		67,00		73,00		m
	0°	0°	0°	0°	0°	0°	0°	22°	0°	22°	0°	22°	0°	22°	0°	22°			
16,0	32,0	-	-	-	-	-	-	-	-	-	-	-	-	-	-	-	-	-	16,0
18,0	32,0	27,0	-	-	-	-	-	-	-	-	-	-	-	-	-	-	-	-	18,0
20,0	32,0	26,5	22,0	-	-	-	-	-	-	-	-	-	-	-	-	-	-	-	20,0
22,0	32,0	26,5	22,0	17,9	-	-	-	-	-	-	-	-	-	-	-	-	-	-	22,0
24,0	32,0	26,5	21,5	17,9	15,0	-	-	-	9,9	-	-	-	-	-	-	-	-	-	24,0
26,0	32,0	26,5	21,5	17,9	15,0	11,9	-	-	9,9	-	-	-	-	-	-	-	-	-	26,0
28,0	32,0	26,5	21,5	17,9	15,0	11,9	12,2	9,9	-	-	-	-	-	-	-	-	-	-	28,0
30,0	32,0	26,5	21,5	17,9	15,0	11,9	12,2	9,9	-	8,3	-	-	-	-	-	-	-	-	30,0
32,0	-	26,5	21,5	17,9	15,0	11,9	12,2	9,9	10,2	8,3	-	-	6,8	-	-	-	-	-	32,0
34,0	-	26,5	21,5	17,9	15,0	11,9	12,2	9,9	10,2	8,3	-	6,8	-	-	-	-	-	-	34,0
36,0	-	26,5	21,5	17,9	15,0	11,9	12,2	9,9	10,2	8,3	8,5	6,8	-	-	-	-	-	-	36,0
38,0	-	-	21,5	17,9	15,0	11,9	12,2	9,9	10,2	8,3	8,5	6,8	-	-	-	-	-	-	38,0
40,0	-	-	21,5	17,9	15,0	11,9	12,2	9,9	10,2	8,3	8,5	6,8	7,0	-	-	-	-	-	40,0
42,0	-	-	21,5	17,9	15,0	11,9	12,2	9,9	10,2	8,3	8,5	6,8	7,0	-	-	-	-	-	42,0
44,0	-	-	-	17,9	15,0	11,9	12,2	9,9	10,2	8,3	8,5	6,8	7,0	-	-	-	-	-	44,0
46,0	-	-	-	17,9	15,0	11,9	12,2	9,9	10,2	8,3	8,5	6,8	7,0	-	-	-	-	-	46,0
48,0	-	-	-	-	15,0	11,9	12,2	9,9	10,2	8,3	8,5	6,8	7,0	-	-	-	-	-	48,0
50,0	-	-	-	-	15,0	11,9	12,2	9,9	10,2	8,3	8,5	6,8	7,0	-	-	-	-	-	50,0
52,0	-	-	-	-	15,0	11,9	12,2	9,9	10,2	8,3	8,5	6,8	7,0	-	-	-	-	-	52,0
54,0	-	-	-	-	-	11,9	12,2	9,9	10,2	8,3	8,5	6,8	7,0	-	-	-	-	-	54,0
56,0	-	-	-	-	-	11,9	12,2	9,9	10,2	8,3	8,5	6,8	7,0	-	-	-	-	-	56,0
58,0	-	-	-	-	-	11,9	-	9,9	10,2	8,4	8,5	6,8	7,0	-	-	-	-	-	58,0
60,0	-	-	-	-	-	-	-	9,9	10,2	8,3	8,5	6,8	7,0	-	-	-	-	-	60,0
62,0	-	-	-	-	-	-	-	9,9	10,2	8,3	8,5	6,8	7,0	-	-	-	-	-	62,0
64,0	-	-	-	-	-	-	-	-	9,9	8,3	8,5	6,8	7,0	-	-	-	-	-	64,0
66,0	-	-	-	-	-	-	-	-	-	8,3	8,5	6,8	7,0	-	-	-	-	-	66,0
68,0	-	-	-	-	-	-	-	-	-	8,3	8,5	6,8	7,0	-	-	-	-	-	68,0
70,0	-	-	-	-	-	-	-	-	-	8,3	-	6,8	7,0	-	-	-	-	-	70,0
72,0	-	-	-	-	-	-	-	-	-	-	-	6,8	7,0	-	-	-	-	-	72,0
74,0	-	-	-	-	-	-	-	-	-	-	-	6,8	7,0	-	-	-	-	-	74,0
76,0	-	-	-	-	-	-	-	-	-	-	-	6,8	-	-	-	-	-	-	76,0



80°
44,79 m



0-22°
25 - 73 m



8,5 m



360°



135 t



EN 13000

m	25,00		31,00		37,00		43,00		49,00		55,00		61,00		67,00		73,00		m
	0°	0°	0°	0°	0°	0°	22°	0°	22°	0°	22°	0°	22°	0°	22°	0°	22°		
18,0	23,5	-	-	-	-	-	-	-	-	-	-	-	-	-	-	-	-	-	18,0
20,0	23,5	19,3	-	-	-	-	-	-	-	-	-	-	-	-	-	-	-	-	20,0
22,0	23,5	19,3	15,8	-	-	-	-	-	-	-	-	-	-	-	-	-	-	-	22,0
24,0	23,0	19,3	15,8	12,9	-	-	-	-	-	-	-	-	-	-	-	-	-	-	24,0
26,0	22,5	19,3	15,8	12,9	10,5	-	-	-	-	-	-	-	-	-	-	-	-	-	26,0
28,0	21,5	19,3	15,8	12,9	10,5	8,4	-	-	-	-	-	-	-	-	-	-	-	-	28,0
30,0	20,5	18,9	15,8	12,9	10,5	8,4	8,6	6,9	-	-	-	-	-	-	-	-	-	-	30,0
32,0	19,9	18,3	15,8	12,9	10,5	8,4	8,6	6,9	-	5,6	-	-	-	-	-	-	-	-	32,0
34,0	-	17,6	15,8	12,9	10,5	8,4	8,6	6,9	7,1	5,6	-	4,4	-	-	-	-	-	-	34,0
36,0	-	16,9	15,6	12,9	10,5	8,4	8,6	6,9	7,1	5,6	-	4,4	-	-	-	-	-	-	36,0
38,0	-	16,3	15,1	12,9	10,5	8,4	8,6	6,9	7,1	5,6	5,8	4,4	-	-	-	-	-	-	38,0
40,0	-	-	14,6	12,9	10,5	8,4	8,6	6,9	7,1	5,6	5,8	4,4	-	-	-	-	-	-	40,0
42,0	-	-	14,1	12,5	10,5	8,4	8,6	6,9	7,1	5,6	5,8	4,4	4,6	-	-	-	-	-	42,0
44,0	-	-	13,6	12,1	10,5	8,4	8,6	6,9	7,1	5,6	5,8	4,4	4,6	4,6	-	-	-	-	44,0
46,0	-	-	-	11,7	10,5	8,4	8,6	6,9	7,1	5,6	5,8	4,4	4,6	4,6	-	-	-	-	46,0
48,0	-	-	-	11,4	10,5	8,4	8,6	6,9	7,1	5,6	5,8	4,4	4,6	4,6	-	-	-	-	48,0
50,0	-	-	-	11,0	10,2	8,4	8,6	6,9	7,1	5,6	5,8	4,4	4,6	4,6	-	-	-	-	50,0
52,0	-	-	-	-	9,9	8,4	8,6	6,9	7,1	5,6	5,8	4,4	4,6	4,6	-	-	-	-	52,0
54,0	-	-	-	-	9,6	8,4	8,6	6,9	7,1	5,6	5,8	4,4	4,6	4,6	-	-	-	-	54,0
56,0	-	-	-	-	-	8,3	8,4	6,9	7,1	5,6	5,8	4,4	4,6	4,6	-	-	-	-	56,0
58,0	-	-	-	-	-	8,1	8,2	6,9	7,1	5,6	5,8	4,4	4,6	4,6	-	-	-	-	58,0
60,0	-	-	-	-	-	7,9	-	6,9	7,1	5,6	5,8	4,4	4,6	4,6	-	-	-	-	60,0
62,0	-	-	-	-	-	-	-	6,9	7,1	5,6	5,8	4,4	4,6	4,6	-	-	-	-	62,0
64,0	-	-	-	-	-	-	-	6,8	6,9	5,6	5,8	4,4	4,6	4,6	-	-	-	-	64,0
66,0	-	-	-	-	-	-	-	-	6,6	-	5,6	5,8	4,4	4,6	-	-	-	-	66,0
68,0	-	-	-	-	-	-	-	-	-	-	5,6	5,8	4,4	4,6	-	-	-	-	68,0
70,0	-	-	-	-	-	-	-	-	-	-	5,6	5,8	4,4	4,6	-	-	-	-	70,0
72,0	-	-	-	-	-	-	-	-	-	-	-	4,4	4,6	4,6	-	-	-	-	72,0
74,0	-	-	-	-	-	-	-	-	-	-	-	4,4	4,6	4,6	-	-	-	-	74,0
76,0	-	-	-	-	-	-	-	-	-	-	-	4,4	4,6	4,6	-	-	-	-	76,0
78,0	-	-	-	-	-	-	-	-	-	-	-	4,4	-	-	-	-	-	-	78,0

Load charts • Traglasten • Capacités de levage Capacidades • Capacità • Таблицы грузоподъемности

Luffing jib • Wippspitzenausleger • Volée variable • Plumín de angulación variable • Jib a volata variable • Маневровый гусек



80°
54,59 m



0-22°
25 - 67 m



8,5 m



360°



135 t



EN 13000

m	25,00	31,00	37,00	43,00	49,00	55,00		61,00		67,00		m
	0°	0°	0°	0°	0°	0°	22°	0°	22°	0°	22°	
22,0	15,0	-	-	-	-	-	-	-	-	-	-	22,0
24,0	15,0	12,0	-	-	-	-	-	-	-	-	-	24,0
26,0	15,0	12,0	9,6	-	-	-	-	-	-	-	-	26,0
28,0	15,0	12,0	9,6	7,5	-	-	-	-	-	-	-	28,0
30,0	15,0	12,0	9,6	7,5	6,0	-	-	-	-	-	-	30,0
32,0	14,9	12,0	9,6	7,5	6,0	4,5	4,6	-	-	-	-	32,0
34,0	14,1	12,0	9,6	7,5	6,0	4,5	4,6	3,4	-	-	-	34,0
36,0	13,4	11,7	9,6	7,5	6,0	4,5	4,6	3,4	-	2,5	-	36,0
38,0	-	11,4	9,6	7,5	6,0	4,5	4,6	3,4	3,6	2,5	-	38,0
40,0	-	11,0	9,6	7,5	6,0	4,5	4,6	3,4	3,6	2,5	-	40,0
42,0	-	-	9,5	7,5	6,0	4,5	4,6	3,4	3,6	2,5	2,7	42,0
44,0	-	-	9,3	7,5	6,0	4,5	4,6	3,4	3,6	2,5	2,7	44,0
46,0	-	-	9,0	7,5	6,0	4,5	4,6	3,4	3,6	2,5	2,7	46,0
48,0	-	-	-	7,5	6,0	4,5	4,6	3,4	3,6	2,5	2,7	48,0
50,0	-	-	-	7,5	6,0	4,5	4,6	3,4	3,6	2,5	2,7	50,0
52,0	-	-	-	7,2	6,0	4,5	4,6	3,4	3,6	2,5	2,7	52,0
54,0	-	-	-	-	6,0	4,5	4,6	3,4	3,6	2,5	2,7	54,0
56,0	-	-	-	-	6,0	4,5	4,6	3,4	3,6	2,5	2,7	56,0
58,0	-	-	-	-	5,9	4,5	4,6	3,4	3,6	2,5	2,7	58,0
60,0	-	-	-	-	-	4,5	4,6	3,4	3,6	2,5	2,7	60,0
62,0	-	-	-	-	-	4,5	4,6	3,4	3,6	2,5	2,7	62,0
64,0	-	-	-	-	-	4,5	-	3,4	3,6	2,5	2,7	64,0
66,0	-	-	-	-	-	-	-	3,4	3,6	2,5	2,7	66,0
68,0	-	-	-	-	-	-	-	3,4	3,6	2,5	2,7	68,0
70,0	-	-	-	-	-	-	-	3,4	-	2,5	2,7	70,0
72,0	-	-	-	-	-	-	-	-	-	2,5	2,7	72,0
74,0	-	-	-	-	-	-	-	-	-	2,5	2,7	74,0
76,0	-	-	-	-	-	-	-	-	-	2,5	-	76,0

Load charts • Traglasten • Capacités de levage Capacidades • Capacità • Таблицы грузоподъемности

Luffing jib • Wippspitzenausleger • Volée variable • Plumín de angulación variable • Jib a volata variable • Маневровый гусек



70°
15,39 m



0-22°
25 - 73 m



8,5 m



360°



135 t



EN 13000

m	25,00		31,00		37,00		43,00		49,00		55,00		61,00		67,00		73,00		m
	0°	0°	0°	0°	0°	0°	0°	22°	0°	22°	0°	22°	0°	22°	0°	22°			
18,0	51,5	-	-	-	-	-	-	-	-	-	-	-	-	-	-	-	-	-	18,0
20,0	49,0	-	-	-	-	-	-	-	-	-	-	-	-	-	-	-	-	-	20,0
22,0	46,5	42,0	-	-	-	-	-	-	-	-	-	-	-	-	-	-	-	-	22,0
24,0	43,5	40,5	-	-	-	-	-	-	-	-	-	-	-	-	-	-	-	-	24,0
26,0	41,5	39,0	34,5	-	-	-	-	-	-	-	-	-	-	-	-	-	-	-	26,0
28,0	39,0	37,5	33,5	29,0	-	-	-	-	-	-	-	-	-	-	-	-	-	-	28,0
30,0	-	36,0	32,5	29,0	24,0	-	-	-	-	-	-	-	-	-	-	-	-	-	30,0
32,0	-	33,5	31,5	28,0	24,0	-	-	-	-	-	-	-	-	-	-	-	-	-	32,0
34,0	-	31,0	30,5	27,5	23,5	19,8	20,0	-	-	-	-	-	-	-	-	-	-	-	34,0
36,0	-	-	29,0	27,0	23,5	19,7	19,9	16,9	-	-	-	-	-	-	-	-	-	-	36,0
38,0	-	-	27,0	26,0	23,0	19,6	19,8	16,9	-	-	-	-	-	-	-	-	-	-	38,0
40,0	-	-	25,5	25,0	23,0	19,5	19,7	16,8	16,9	14,5	-	-	-	-	-	-	-	-	40,0
42,0	-	-	-	23,5	22,5	19,4	19,5	16,7	16,8	14,5	-	-	11,6	-	-	-	-	-	42,0
44,0	-	-	-	22,5	22,0	19,2	19,4	16,6	16,7	14,4	11,8	11,3	-	-	-	-	-	-	44,0
46,0	-	-	-	21,0	21,0	18,9	19,0	16,6	16,7	14,2	11,6	11,0	-	-	-	-	-	-	46,0
48,0	-	-	-	-	20,0	18,6	18,7	16,5	16,6	13,9	11,4	10,7	-	-	-	-	-	-	48,0
50,0	-	-	-	-	19,0	18,3	18,4	16,3	16,5	13,7	11,2	10,4	8,4	-	-	-	-	-	50,0
52,0	-	-	-	-	17,7	17,6	17,6	16,1	16,3	13,3	11,1	10,1	8,2	-	-	-	-	-	52,0
54,0	-	-	-	-	-	16,8	16,8	15,9	16,1	12,9	10,9	9,8	8,0	-	-	-	-	-	54,0
56,0	-	-	-	-	-	16,0	16,0	15,7	15,8	12,5	10,8	9,5	7,9	-	-	-	-	-	56,0
58,0	-	-	-	-	-	14,6	-	15,1	15,1	12,1	10,7	9,3	7,8	-	-	-	-	-	58,0
60,0	-	-	-	-	-	-	-	14,4	14,4	11,8	10,6	9,0	7,6	-	-	-	-	-	60,0
62,0	-	-	-	-	-	-	-	13,7	13,7	11,5	10,5	8,7	7,5	-	-	-	-	-	62,0
64,0	-	-	-	-	-	-	-	12,2	-	11,3	10,5	8,5	7,4	-	-	-	-	-	64,0
66,0	-	-	-	-	-	-	-	-	-	11,0	10,5	8,3	7,4	-	-	-	-	-	66,0
68,0	-	-	-	-	-	-	-	-	-	10,8	10,5	8,1	7,3	-	-	-	-	-	68,0
70,0	-	-	-	-	-	-	-	-	-	10,2	-	7,9	7,3	-	-	-	-	-	70,0
72,0	-	-	-	-	-	-	-	-	-	-	-	7,7	7,3	-	-	-	-	-	72,0
74,0	-	-	-	-	-	-	-	-	-	-	-	7,5	7,3	-	-	-	-	-	74,0
76,0	-	-	-	-	-	-	-	-	-	-	-	7,4	-	-	-	-	-	-	76,0



80°
25,19 m



0-22°
25 - 73 m



8,5 m



360°



135 t



EN 13000

m	25,00		31,00		37,00		43,00		49,00		55,00		61,00		67,00		73,00		m
	0°	0°	0°	0°	0°	0°	0°	22°	0°	22°	0°	22°	0°	22°	0°	22°			
22,0	48,0	-	-	-	-	-	-	-	-	-	-	-	-	-	-	-	-	-	22,0
24,0	43,5	-	-	-	-	-	-	-	-	-	-	-	-	-	-	-	-	-	24,0
26,0	40,0	39,5	-	-	-	-	-	-	-	-	-	-	-	-	-	-	-	-	26,0
28,0	37,0	36,5	32,0	-	-	-	-	-	-	-	-	-	-	-	-	-	-	-	28,0
30,0	34,0	33,5	32,0	-	-	-	-	-	-	-	-	-	-	-	-	-	-	-	30,0
32,0	31,5	31,0	31,0	26,5	-	-	-	-	-	-	-	-	-	-	-	-	-	-	32,0
34,0	-	29,0	29,0	26,5	22,0	-	-	-	-	-	-	-	-	-	-	-	-	-	34,0
36,0	-	27,0	27,0	26,5	22,0	-	-	-	-	-	-	-	-	-	-	-	-	-	36,0
38,0	-	25,5	25,0	25,0	22,0	18,0	-	-	-	-	-	-	-	-	-	-	-	-	38,0
40,0	-	-	23,5	23,5	22,0	18,0	18,3	15,3	-	-	-	-	-	-	-	-	-	-	40,0
42,0	-	-	22,5	22,0	22,0	18,0	18,3	15,3	-	-	-	-	-	-	-	-	-	-	42,0
44,0	-	-	21,0	20,5	20,5	18,0	18,3	15,3	15,4	12,9	-	-	-	-	-	-	-	-	44,0
46,0	-	-	-	19,6	19,4	18,0	18,3	15,3	15,4	12,9	-	-	-	-	-	-	-	-	46,0
48,0	-	-	-	18,5	18,4	18,0	17,9	15,3	15,4	12,9	11,5	10,6	-	-	-	-	-	-	48,0
50,0	-	-	-	17,6	17,5	17,0	17,0	15,3	15,4	12,9	11,3	10,4	-	-	-	-	-	-	50,0
52,0	-	-	-	-	16,6	16,2	16,1	15,3	15,4	12,9	11,2	10,2	-	-	-	-	-	-	52,0
54,0	-	-	-	-	15,8	15,4	15,3	15,1	15,1	12,9	11,0	10,0	8,3	-	-	-	-	-	54,0
56,0	-	-	-	-	15,0	14,6	14,6	14,4	14,4	12,8	10,9	9,8	8,1	-	-	-	-	-	56,0
58,0	-	-	-	-	-	13,9	13,9	13,7	13,7	12,4	10,8	9,5	8,0	-	-	-	-	-	58,0
60,0	-	-	-	-	-	13,3	13,2	13,1	13,1	12,1	10,7	9,3	7,8	-	-	-	-	-	60,0
62,0	-	-	-	-	-	12,6	-	12,5	12,5	11,8	10,6	9,1	7,7	-	-	-	-	-	62,0
64,0	-	-	-	-	-	-	-	11,9	11,9	11,6	10,5	8,9	7,6	-	-	-	-	-	64,0
66,0	-	-	-	-	-	-	-	11,4	11,4	11,3	10,5	8,7	7,5	-	-	-	-	-	66,0
68,0	-	-	-	-	-	-	-	10,9	-	10,8	10,4	8,5	7,4	-	-	-	-	-	68,0
70,0	-	-	-	-	-	-	-	-	-	10,3	10,4	8,3	7,3	-	-	-	-	-	70,0
72,0	-	-	-	-	-	-	-	-	-	9,8	10,0	8,1	7,3	-	-	-	-	-	72,0
74,0	-	-	-	-	-	-	-	-	-	-	-	7,9	7,3	-	-	-	-	-	74,0
76,0	-	-	-	-	-	-	-	-	-	-	-	7,8	7,3	-	-	-	-	-	76,0
78,0	-	-	-	-	-	-	-	-	-	-	-	7,6	-	-	-	-	-	-	78,0
80,0	-	-	-	-	-	-	-	-	-	-	-	7,5	-	-	-	-	-	-	80,0

Load charts • Traglasten • Capacités de levage Capacidades • Capacità • Таблицы грузоподъемности

Luffing jib • Wippspitzenausleger • Volée variable • Plumín de angulación variable • Jib a volata variable • Маневровый гусек



70°
34,99 m



0-22°
25 - 73 m



8,5 m



360°



135 t



EN 13000

m	25,00		31,00		37,00		43,00		49,00		55,00		61,00		67,00		73,00		m
	0°	0°	0°	0°	0°	0°	0°	22°	0°	22°	0°	22°	0°	22°	0°	22°			
26,0	33,0	-	-	-	-	-	-	-	-	-	-	-	-	-	-	-	-	-	26,0
28,0	32,5	-	-	-	-	-	-	-	-	-	-	-	-	-	-	-	-	-	28,0
30,0	32,0	26,5	-	-	-	-	-	-	-	-	-	-	-	-	-	-	-	-	30,0
32,0	30,0	26,5	-	-	-	-	-	-	-	-	-	-	-	-	-	-	-	-	32,0
34,0	28,0	26,5	21,5	-	-	-	-	-	-	-	-	-	-	-	-	-	-	-	34,0
36,0	26,0	25,5	21,5	18,1	-	-	-	-	-	-	-	-	-	-	-	-	-	-	36,0
38,0	-	24,0	21,5	18,1	-	-	-	-	-	-	-	-	-	-	-	-	-	-	38,0
40,0	-	22,5	21,5	18,1	15,3	-	-	-	-	-	-	-	-	-	-	-	-	-	40,0
42,0	-	21,5	21,0	18,1	14,9	12,4	-	-	-	-	-	-	-	-	-	-	-	-	42,0
44,0	-	-	20,0	18,1	14,9	12,3	12,3	-	-	-	-	-	-	-	-	-	-	-	44,0
46,0	-	-	18,9	18,1	14,9	12,1	12,3	10,4	-	-	-	-	-	-	-	-	-	-	46,0
48,0	-	-	17,9	17,6	14,9	12,1	12,3	10,3	10,6	8,7	-	-	-	-	-	-	-	-	48,0
50,0	-	-	-	16,7	14,9	12,1	12,3	10,2	10,6	8,7	-	-	7,1	-	-	-	-	-	50,0
52,0	-	-	-	15,8	14,9	11,9	12,3	10,2	10,5	8,7	-	-	7,1	-	-	-	-	-	52,0
54,0	-	-	-	15,0	14,8	11,9	12,3	10,2	10,5	8,7	9,0	-	7,1	-	-	-	-	-	54,0
56,0	-	-	-	-	14,1	11,9	12,3	10,2	10,4	8,7	9,0	-	7,1	-	-	-	-	-	56,0
58,0	-	-	-	-	13,4	11,9	12,3	10,2	10,2	8,7	8,9	-	7,1	7,4	-	-	-	-	58,0
60,0	-	-	-	-	12,7	11,9	12,3	10,2	10,2	8,7	8,9	-	7,1	7,4	-	-	-	-	60,0
62,0	-	-	-	-	-	11,9	11,9	10,2	10,2	8,7	8,9	-	7,1	7,4	-	-	-	-	62,0
64,0	-	-	-	-	-	11,3	-	10,2	10,2	8,7	8,9	-	7,1	7,4	-	-	-	-	64,0
66,0	-	-	-	-	-	10,8	-	10,2	10,2	8,7	8,9	-	7,1	7,4	-	-	-	-	66,0
68,0	-	-	-	-	-	-	-	10,2	10,2	8,7	8,9	-	7,1	7,4	-	-	-	-	68,0
70,0	-	-	-	-	-	-	-	-	9,7	-	8,9	-	7,1	7,3	-	-	-	-	70,0
72,0	-	-	-	-	-	-	-	-	9,3	-	8,9	-	7,1	7,2	-	-	-	-	72,0
74,0	-	-	-	-	-	-	-	-	-	-	8,8	-	7,1	7,2	-	-	-	-	74,0
76,0	-	-	-	-	-	-	-	-	-	-	8,7	-	7,1	7,2	-	-	-	-	76,0
78,0	-	-	-	-	-	-	-	-	-	-	8,4	-	7,1	7,2	-	-	-	-	78,0
80,0	-	-	-	-	-	-	-	-	-	-	-	-	7,1	7,2	-	-	-	-	80,0
82,0	-	-	-	-	-	-	-	-	-	-	-	-	7,1	-	-	-	-	-	82,0



70°
44,79 m



0-22°
25 - 73 m



8,5 m



360°



135 t



EN 13000

m	25,00		31,00		37,00		43,00		49,00		55,00		61,00		67,00		73,00		m
	0°	0°	0°	0°	0°	0°	22°	0°	22°	0°	22°	0°	22°	0°	22°	0°	22°		
30,0	19,3	-	-	-	-	-	-	-	-	-	-	-	-	-	-	-	-	-	30,0
32,0	18,3	-	-	-	-	-	-	-	-	-	-	-	-	-	-	-	-	-	32,0
34,0	17,4	16,4	-	-	-	-	-	-	-	-	-	-	-	-	-	-	-	-	34,0
36,0	16,4	15,6	-	-	-	-	-	-	-	-	-	-	-	-	-	-	-	-	36,0
38,0	15,4	14,9	14,0	-	-	-	-	-	-	-	-	-	-	-	-	-	-	-	38,0
40,0	14,4	14,1	13,5	12,0	-	-	-	-	-	-	-	-	-	-	-	-	-	-	40,0
42,0	-	13,3	12,6	11,5	-	-	-	-	-	-	-	-	-	-	-	-	-	-	42,0
44,0	-	12,2	11,6	11,0	10,3	-	-	-	-	-	-	-	-	-	-	-	-	-	44,0
46,0	-	11,1	10,9	10,4	9,9	-	-	-	-	-	-	-	-	-	-	-	-	-	46,0
48,0	-	-	10,4	9,9	9,6	8,6	8,7	-	-	-	-	-	-	-	-	-	-	-	48,0
50,0	-	-	9,8	9,4	9,1	8,3	8,4	7,2	-	-	-	-	-	-	-	-	-	-	50,0
52,0	-	-	9,2	8,9	8,7	8,0	8,1	7,2	-	-	-	-	5,9	-	-	-	-	-	52,0
54,0	-	-	-	8,5	8,2	7,7	7,8	7,1	7,3	5,9	-	-	4,7	-	-	-	-	-	54,0
56,0	-	-	-	8,0	7,8	7,3	7,4	6,9	7,0	5,9	-	-	4,7	-	-	-	-	-	56,0
58,0	-	-	-	7,5	7,4	7,0	7,0	6,6	6,8	5,9	6,2	-	4,7	-	-	-	-	-	58,0
60,0	-	-	-	-	7,0	6,6	6,7	6,3	6,5	5,9	6,1	-	4,7	-	-	-	-	-	60,0
62,0	-	-	-	-	6,7	6,3	6,3	6,0	6,2	5,7	5,9	-	4,7	4,9	-	-	-	-	62,0
64,0	-	-	-	-	6,3	6,0	6,0	5,7	5,9	5,5	5,7	-	4,7	4,9	-	-	-	-	64,0
66,0	-	-	-	-	-	5,6	5,7	5,4	5,6	5,2	5,4	-	4,7	4,9	-	-	-	-	66,0
68,0	-	-	-	-	-	5,3	-	5,1	5,3	5,0	5,2	-	4,6	4,8	-	-	-	-	68,0
70,0	-	-	-	-	-	5,0	-	4,9	5,0	4,7	4,9	-	4,4	4,6	-	-	-	-	70,0
72,0	-	-	-	-	-	-	-	4,6	4,7	4,5	4,6	-	4,2	4,4	-	-	-	-	72,0
74,0	-	-	-	-	-	-	-	4,3	4,4	4,2	4,4	-	4,0	4,2	-	-	-	-	74,0
76,0	-	-	-	-	-	-	-	4,0	-	4,0	4,1	-	3,7	4,0	-	-	-	-	76,0
78,0	-	-	-	-	-	-	-	-	-	3,7	3,9	-	3,5	3,7	-	-	-	-	78,0
80,0	-	-	-	-	-	-	-	-	-	3,5	-	-	3,3	3,5	-	-	-	-	80,0
82,0	-	-	-	-	-	-	-	-	-	-	-	-	3,1	3,3	-	-	-	-	82,0
84,0	-	-	-	-	-	-	-	-	-	-	-	-	2,9	3,1	-	-	-	-	84,0
86,0	-	-	-	-	-	-	-	-	-	-	-	-	2,7	-	-	-	-	-	86,0

Load charts • Traglasten • Capacités de levage Capacidades • Capacità • Таблицы грузоподъемности

Luffing jib • Wippspitzenausleger • Volée variable • Plumín de angulación variable • Jib a volata variable • Маневровый гусек



70°
44,59 m



0-22°
25 - 67 m



8,5 m



360°



135 t



EN 13000

m	25,00	31,00	37,00	43,00	49,00	55,00		61,00		67,00		m
	0°	0°	0°	0°	0°	0°	22°	0°	22°	0°	22°	
36,0	11,8	-	-	-	-	-	-	-	-	-	-	36,0
38,0	11,3	-	-	-	-	-	-	-	-	-	-	38,0
40,0	10,8	9,9	-	-	-	-	-	-	-	-	-	40,0
42,0	10,4	9,5	8,6	-	-	-	-	-	-	-	-	42,0
44,0	9,9	9,1	8,3	-	-	-	-	-	-	-	-	44,0
46,0	-	8,7	8,0	7,0	-	-	-	-	-	-	-	46,0
48,0	-	8,3	7,7	6,8	-	-	-	-	-	-	-	48,0
50,0	-	8,0	7,3	6,5	5,8	-	-	-	-	-	-	50,0
52,0	-	-	7,0	6,2	5,6	4,7	-	-	-	-	-	52,0
54,0	-	-	6,8	6,0	5,4	4,6	4,6	-	-	-	-	54,0
56,0	-	-	6,5	5,7	5,2	4,4	4,5	3,7	-	-	-	56,0
58,0	-	-	-	5,5	5,0	4,2	4,3	3,6	3,8	2,8	-	58,0
60,0	-	-	-	5,3	4,8	4,0	4,1	3,5	3,6	2,8	-	60,0
62,0	-	-	-	5,1	4,6	3,9	3,9	3,3	3,5	2,8	-	62,0
64,0	-	-	-	-	4,4	3,7	3,7	3,2	3,3	2,8	2,9	64,0
66,0	-	-	-	-	4,2	3,5	3,6	3,0	3,2	2,6	2,8	66,0
68,0	-	-	-	-	4,0	3,3	3,4	2,9	3,0	2,5	2,7	68,0
70,0	-	-	-	-	-	3,2	3,2	2,8	2,9	2,4	2,6	70,0
72,0	-	-	-	-	-	3,0	3,1	2,6	2,7	2,3	2,4	72,0
74,0	-	-	-	-	-	2,9	-	2,5	2,6	2,1	2,3	74,0
76,0	-	-	-	-	-	-	-	2,3	2,4	2,0	2,1	76,0
78,0	-	-	-	-	-	-	-	2,2	2,3	1,9	2,0	78,0
80,0	-	-	-	-	-	-	-	2,1	-	1,8	1,9	80,0
82,0	-	-	-	-	-	-	-	-	-	1,7	1,8	82,0
84,0	-	-	-	-	-	-	-	-	-	-	1,7	84,0

Load charts • Traglasten • Capacités de levage Capacidades • Capacità • Таблицы грузоподъемности

Luffing jib • Wippspitzenausleger • Volée variable • Plumín de angulación variable • Jib a volata variable • Маневровый гусек



60°
15,39 m



0-22°
25 - 73 m



8,5 m



360°



135 t



EN 13000

m	25,00		31,00		37,00		43,00		49,00		55,00		61,00		67,00		73,00		m
	0°	0°	0°	0°	0°	0°	0°	22°	0°	22°	0°	22°	0°	22°	0°	22°			
26,0	41,0	-	-	-	-	-	-	-	-	-	-	-	-	-	-	-	-	-	26,0
28,0	37,5	-	-	-	-	-	-	-	-	-	-	-	-	-	-	-	-	-	28,0
30,0	35,0	34,5	-	-	-	-	-	-	-	-	-	-	-	-	-	-	-	-	30,0
32,0	32,0	32,0	-	-	-	-	-	-	-	-	-	-	-	-	-	-	-	-	32,0
34,0	-	30,0	29,5	-	-	-	-	-	-	-	-	-	-	-	-	-	-	-	34,0
36,0	-	28,0	27,5	26,5	-	-	-	-	-	-	-	-	-	-	-	-	-	-	36,0
38,0	-	26,0	26,0	25,5	-	-	-	-	-	-	-	-	-	-	-	-	-	-	38,0
40,0	-	-	24,5	24,0	22,5	-	-	-	-	-	-	-	-	-	-	-	-	-	40,0
42,0	-	-	23,0	22,5	22,0	-	-	-	-	-	-	-	-	-	-	-	-	-	42,0
44,0	-	-	21,5	21,0	21,0	18,7	-	-	-	-	-	-	-	-	-	-	-	-	44,0
46,0	-	-	-	20,0	20,0	18,5	18,7	-	-	-	-	-	-	-	-	-	-	-	46,0
48,0	-	-	-	19,1	18,9	18,3	18,4	16,0	-	-	-	-	-	-	-	-	-	-	48,0
50,0	-	-	-	18,1	18,0	17,5	17,5	16,0	16,1	-	-	-	-	-	-	-	-	-	50,0
52,0	-	-	-	-	17,1	16,6	16,6	15,9	16,0	13,6	-	-	-	-	-	-	-	-	52,0
54,0	-	-	-	-	16,2	15,8	15,8	15,6	15,6	13,3	-	-	-	-	-	-	-	-	54,0
56,0	-	-	-	-	-	15,1	15,0	14,9	14,9	13,1	10,9	-	-	-	-	-	-	-	56,0
58,0	-	-	-	-	-	14,3	14,3	14,2	14,2	12,7	10,8	9,6	-	-	-	-	-	-	58,0
60,0	-	-	-	-	-	13,7	-	13,5	13,5	12,3	10,7	9,3	-	-	-	-	-	-	60,0
62,0	-	-	-	-	-	-	-	12,9	12,9	11,9	10,6	9,1	7,7	-	-	-	-	-	62,0
64,0	-	-	-	-	-	-	-	12,3	12,3	11,6	10,5	8,8	7,6	-	-	-	-	-	64,0
66,0	-	-	-	-	-	-	-	-	11,8	-	11,4	10,5	8,6	7,5	-	-	-	-	66,0
68,0	-	-	-	-	-	-	-	-	-	-	11,1	10,4	8,3	7,4	-	-	-	-	68,0
70,0	-	-	-	-	-	-	-	-	-	-	10,7	10,4	8,1	7,3	-	-	-	-	70,0
72,0	-	-	-	-	-	-	-	-	-	-	10,2	-	7,9	7,3	-	-	-	-	72,0
74,0	-	-	-	-	-	-	-	-	-	-	-	-	7,7	7,2	-	-	-	-	74,0
76,0	-	-	-	-	-	-	-	-	-	-	-	-	7,6	7,2	-	-	-	-	76,0
78,0	-	-	-	-	-	-	-	-	-	-	-	-	7,4	-	-	-	-	-	78,0



60°
25,19 m



0-22°
25 - 73 m



8,5 m



360°



135 t



EN 13000

m	25,00		31,00		37,00		43,00		49,00		55,00		61,00		67,00		73,00		m
	0°	0°	0°	0°	0°	0°	22°	0°	22°	0°	22°	0°	22°	0°	22°				
30,0	31,5	-	-	-	-	-	-	-	-	-	-	-	-	-	-	-	-	-	30,0
32,0	29,0	-	-	-	-	-	-	-	-	-	-	-	-	-	-	-	-	-	32,0
34,0	27,0	27,0	-	-	-	-	-	-	-	-	-	-	-	-	-	-	-	-	34,0
36,0	25,5	25,0	-	-	-	-	-	-	-	-	-	-	-	-	-	-	-	-	36,0
38,0	-	23,5	23,0	-	-	-	-	-	-	-	-	-	-	-	-	-	-	-	38,0
40,0	-	22,0	21,5	-	-	-	-	-	-	-	-	-	-	-	-	-	-	-	40,0
42,0	-	20,5	20,5	20,0	-	-	-	-	-	-	-	-	-	-	-	-	-	-	42,0
44,0	-	-	19,2	18,8	-	-	-	-	-	-	-	-	-	-	-	-	-	-	44,0
46,0	-	-	18,2	17,8	17,6	-	-	-	-	-	-	-	-	-	-	-	-	-	46,0
48,0	-	-	17,2	16,8	16,6	-	-	-	-	-	-	-	-	-	-	-	-	-	48,0
50,0	-	-	-	16,0	15,8	15,3	-	-	-	-	-	-	-	-	-	-	-	-	50,0
52,0	-	-	-	15,1	15,0	14,5	14,5	-	-	-	-	-	-	-	-	-	-	-	52,0
54,0	-	-	-	14,4	14,2	13,8	13,7	13,5	-	-	-	-	-	-	-	-	-	-	54,0
56,0	-	-	-	-	13,5	13,1	13,1	12,8	12,8	-	-	-	-	-	-	-	-	-	56,0
58,0	-	-	-	-	12,9	12,4	12,4	12,2	12,2	12,0	-	-	-	-	-	-	-	-	58,0
60,0	-	-	-	-	12,3	11,8	11,8	11,6	11,6	11,4	-	-	-	-	-	-	-	-	60,0
62,0	-	-	-	-	-	11,3	11,3	11,1	11,1	10,9	10,7	9,5	-	-	-	-	-	-	62,0
64,0	-	-	-	-	-	10,7	10,7	10,5	10,5	10,4	10,5	9,3	-	-	-	-	-	-	64,0
66,0	-	-	-	-	-	10,2	-	10,1	10,1	9,9	10,1	9,1	-	-	-	-	-	-	66,0
68,0	-	-	-	-	-	-	-	9,6	9,6	9,4	9,6	8,9	7,6	-	-	-	-	-	68,0
70,0	-	-	-	-	-	-	-	9,2	9,2	9,0	9,2	8,6	7,5	-	-	-	-	-	70,0
72,0	-	-	-	-	-	-	-	-	8,7	-	8,6	8,8	8,4	7,4	-	-	-	-	72,0
74,0	-	-	-	-	-	-	-	-	-	-	8,2	8,4	8,1	7,3	-	-	-	-	74,0
76,0	-	-	-	-	-	-	-	-	-	-	7,9	8,0	7,8	7,3	-	-	-	-	76,0
78,0	-	-	-	-	-	-	-	-	-	-	7,5	-	7,4	7,2	-	-	-	-	78,0
80,0	-	-	-	-	-	-	-	-	-	-	-	-	7,1	7,1	-	-	-	-	80,0
82,0	-	-	-	-	-	-	-	-	-	-	-	-	6,8	6,8	-	-	-	-	82,0
84,0	-	-	-	-	-	-	-	-	-	-	-	-	6,5	-	-	-	-	-	84,0

Load charts • Traglasten • Capacités de levage Capacidades • Capacità • Таблицы грузоподъемности

Luffing jib • Wippspitzenausleger • Volée variable • Plumín de angulación variable • Jib a volata variable • Маневровый гусек



60°
34,99 m



0-22°
25 - 73 m



8,5 m



360°



135 t



EN 13000

m	25,00		31,00		37,00		43,00		49,00		55,00		61,00		67,00		73,00		m
	0°	0°	0°	0°	0°	0°	0°	22°	0°	22°	0°	22°	0°	22°	0°	22°			
36,0	23,5	-	-	-	-	-	-	-	-	-	-	-	-	-	-	-	-	-	36,0
38,0	22,0	-	-	-	-	-	-	-	-	-	-	-	-	-	-	-	-	-	38,0
40,0	20,5	20,5	-	-	-	-	-	-	-	-	-	-	-	-	-	-	-	-	40,0
42,0	19,3	19,1	-	-	-	-	-	-	-	-	-	-	-	-	-	-	-	-	42,0
44,0	-	18,0	17,7	-	-	-	-	-	-	-	-	-	-	-	-	-	-	-	44,0
46,0	-	17,0	16,7	-	-	-	-	-	-	-	-	-	-	-	-	-	-	-	46,0
48,0	-	16,1	15,8	15,3	-	-	-	-	-	-	-	-	-	-	-	-	-	-	48,0
50,0	-	-	15,0	14,5	-	-	-	-	-	-	-	-	-	-	-	-	-	-	50,0
52,0	-	-	14,2	13,8	13,4	-	-	-	-	-	-	-	-	-	-	-	-	-	52,0
54,0	-	-	13,4	13,1	12,8	-	-	-	-	-	-	-	-	-	-	-	-	-	54,0
56,0	-	-	-	12,4	12,1	11,8	-	-	-	-	-	-	-	-	-	-	-	-	56,0
58,0	-	-	-	11,8	11,5	11,2	11,2	-	-	-	-	-	-	-	-	-	-	-	58,0
60,0	-	-	-	11,2	11,0	10,6	10,6	10,1	-	-	-	-	-	-	-	-	-	-	60,0
62,0	-	-	-	-	10,4	10,1	10,1	9,9	9,9	-	-	-	-	-	-	-	-	-	62,0
64,0	-	-	-	-	9,9	9,6	9,6	9,4	9,4	8,6	-	-	-	-	-	-	-	-	64,0
66,0	-	-	-	-	9,5	9,2	9,2	9,0	8,9	8,6	-	-	-	-	-	-	-	-	66,0
68,0	-	-	-	-	-	8,7	8,7	8,6	8,5	8,4	8,3	7,4	-	-	-	-	-	-	68,0
70,0	-	-	-	-	-	8,3	-	8,1	8,1	8,0	7,9	7,4	-	-	-	-	-	-	70,0
72,0	-	-	-	-	-	7,9	-	7,8	7,7	7,6	7,6	7,3	-	-	-	-	-	-	72,0
74,0	-	-	-	-	-	-	-	7,4	7,4	7,2	7,2	7,0	7,0	-	-	-	-	-	74,0
76,0	-	-	-	-	-	-	-	7,0	-	6,9	6,9	6,6	6,6	-	-	-	-	-	76,0
78,0	-	-	-	-	-	-	-	-	-	6,6	6,5	6,2	6,3	-	-	-	-	-	78,0
80,0	-	-	-	-	-	-	-	-	-	6,2	6,2	5,9	5,9	-	-	-	-	-	80,0
82,0	-	-	-	-	-	-	-	-	-	5,9	-	5,6	5,6	-	-	-	-	-	82,0
84,0	-	-	-	-	-	-	-	-	-	-	-	5,3	5,3	-	-	-	-	-	84,0
86,0	-	-	-	-	-	-	-	-	-	-	-	5,0	5,0	-	-	-	-	-	86,0
88,0	-	-	-	-	-	-	-	-	-	-	-	4,7	-	-	-	-	-	-	88,0



60°
44,79 m



0-22°
25 - 73 m



8,5 m



360°



135 t



EN 13000

m	25,00		31,00		37,00		43,00		49,00		55,00		61,00		67,00		73,00		m
	0°	0°	0°	0°	0°	0°	22°	0°	22°	0°	22°	0°	22°	0°	22°				
42,0	12,0	-	-	-	-	-	-	-	-	-	-	-	-	-	-	-	-	-	42,0
44,0	11,4	-	-	-	-	-	-	-	-	-	-	-	-	-	-	-	-	-	44,0
46,0	10,9	10,2	-	-	-	-	-	-	-	-	-	-	-	-	-	-	-	-	46,0
48,0	10,4	9,8	-	-	-	-	-	-	-	-	-	-	-	-	-	-	-	-	48,0
50,0	-	9,3	8,8	-	-	-	-	-	-	-	-	-	-	-	-	-	-	-	50,0
52,0	-	8,9	8,4	-	-	-	-	-	-	-	-	-	-	-	-	-	-	-	52,0
54,0	-	8,5	8,1	7,4	-	-	-	-	-	-	-	-	-	-	-	-	-	-	54,0
56,0	-	-	7,7	7,1	-	-	-	-	-	-	-	-	-	-	-	-	-	-	56,0
58,0	-	-	7,4	6,8	6,3	-	-	-	-	-	-	-	-	-	-	-	-	-	58,0
60,0	-	-	7,0	6,5	6,0	-	-	-	-	-	-	-	-	-	-	-	-	-	60,0
62,0	-	-	-	6,2	5,8	5,1	-	-	-	-	-	-	-	-	-	-	-	-	62,0
64,0	-	-	-	5,9	5,5	4,9	4,9	-	-	-	-	-	-	-	-	-	-	-	64,0
66,0	-	-	-	-	5,3	4,6	4,7	4,2	-	-	-	-	-	-	-	-	-	-	66,0
68,0	-	-	-	-	5,0	4,4	4,5	4,0	4,2	-	-	-	-	-	-	-	-	-	68,0
70,0	-	-	-	-	4,8	4,2	4,3	3,8	3,9	3,5	-	-	-	-	-	-	-	-	70,0
72,0	-	-	-	-	-	4,0	4,0	3,6	3,7	3,3	-	-	-	-	-	-	-	-	72,0
74,0	-	-	-	-	-	3,8	3,8	3,5	3,6	3,2	3,3	2,8	-	-	-	-	-	-	74,0
76,0	-	-	-	-	-	3,6	-	3,3	3,4	3,0	3,2	2,6	-	-	-	-	-	-	76,0
78,0	-	-	-	-	-	-	-	3,1	3,2	2,8	3,0	2,4	-	-	-	-	-	-	78,0
80,0	-	-	-	-	-	-	-	2,9	3,0	2,7	2,8	2,3	2,5	-	-	-	-	-	80,0
82,0	-	-	-	-	-	-	-	-	2,8	-	2,5	2,6	2,2	2,3	-	-	-	-	82,0
84,0	-	-	-	-	-	-	-	-	-	-	2,4	2,5	2,0	2,2	-	-	-	-	84,0
86,0	-	-	-	-	-	-	-	-	-	-	2,2	2,3	1,9	2,0	-	-	-	-	86,0
88,0	-	-	-	-	-	-	-	-	-	-	-	-	1,7	1,9	-	-	-	-	88,0
90,0	-	-	-	-	-	-	-	-	-	-	-	-	1,6	1,7	-	-	-	-	90,0
92,0	-	-	-	-	-	-	-	-	-	-	-	-	-	1,6	-	-	-	-	92,0

Load charts • Traglasten • Capacités de levage Capacidades • Capacità • Таблицы грузоподъемности

Luffing jib • Wippspitzenausleger • Volée variable • Plumín de angulación variable • Jib a volata variable • Маневровый гусек



60°
54,59 m



0-22°
25 - 49 m



8,5 m



360°



135 t



EN 13000

m	25,00	31,00	37,00	43,00	49,00	m
	0°	0°	0°	0°	0°	
48,0	7,1	-	-	-	-	48,0
50,0	6,8	-	-	-	-	50,0
52,0	6,4	-	-	-	-	52,0
54,0	6,1	5,5	-	-	-	54,0
56,0	-	5,2	4,7	-	-	56,0
58,0	-	5,0	4,5	-	-	58,0
60,0	-	4,7	4,2	-	-	60,0
62,0	-	-	4,0	3,4	-	62,0
64,0	-	-	3,8	3,2	-	64,0
66,0	-	-	3,6	3,0	2,6	66,0
68,0	-	-	-	2,8	2,4	68,0
70,0	-	-	-	2,7	2,3	70,0
72,0	-	-	-	-	2,1	72,0
74,0	-	-	-	-	2,0	74,0
76,0	-	-	-	-	1,8	76,0

Load charts • Traglasten • Capacités de levage Capacidades • Capacità • Таблицы грузоподъемности

MEGAWINGLIFT

Luffing jib • Wippspitzenausleger • Volée variable • Plumín de angulación variable • Jib a volata variable • Маневровый гусек



60° - 70° - 80°
49,69 m



25 - 79 m



8,5 m



360°



135 t

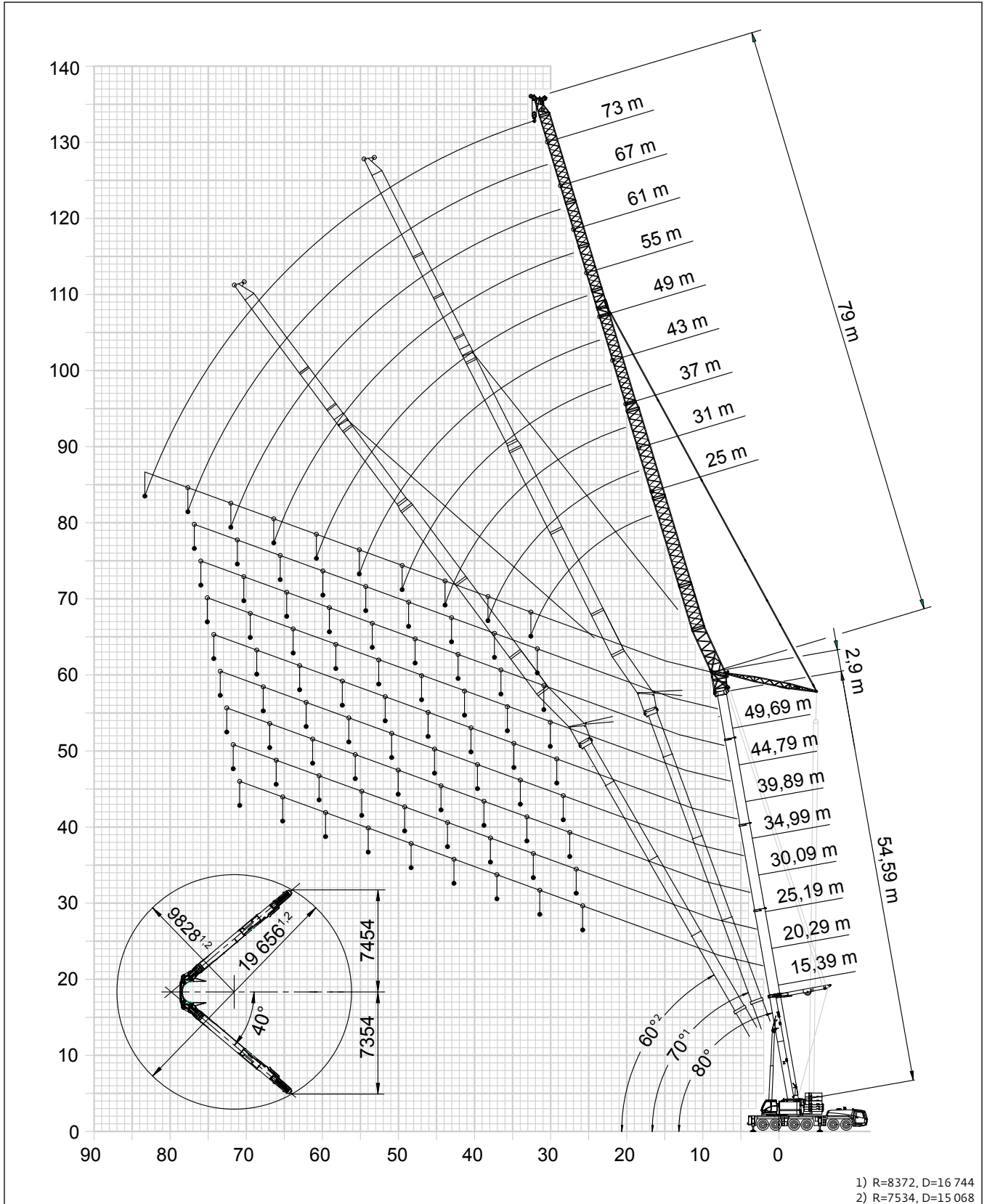

Load charts • Traglasten • Capacités de levage Capacidades • Capacità • Таблицы грузоподъемности

MEGAWINGLIFT

Luffing jib • Wippspitzenausleger • Volée variable • Plumín de angulación variable • Jib a volata variable • Маневровый гусек



80°
34,99 m



0 - 22°
25 - 79 m



8,5 m



360°



135 t



EN 13000

m	25,00		31,00		37,00		43,00		49,00		55,00		61,00		67,00		73,00		79,00		m
	0°	0°	0°	0°	0°	0°	0°	22°	0°	22°	0°	22°	0°	22°	0°	22°	0°	22°	0°		
16,0	59,5	-	-	-	-	-	-	-	-	-	-	-	-	-	-	-	-	-	-	-	16,0
18,0	53,5	48,0	-	-	-	-	-	-	-	-	-	-	-	-	-	-	-	-	-	-	18,0
20,0	49,0	48,0	38,0	-	-	-	-	-	-	-	-	-	-	-	-	-	-	-	-	-	20,0
22,0	45,5	44,5	38,0	31,0	-	-	-	-	-	-	-	-	-	-	-	-	-	-	-	-	22,0
24,0	42,0	41,0	38,0	31,0	25,5	-	-	-	-	-	-	-	-	-	-	-	-	-	-	-	24,0
26,0	39,5	38,0	37,5	31,0	25,5	20,0	-	-	-	-	-	-	-	-	-	-	-	-	-	-	26,0
28,0	37,5	35,5	35,0	31,0	25,5	20,0	21,0	16,7	-	13,9	-	-	-	-	-	-	-	-	-	-	28,0
30,0	36,0	33,5	32,5	31,0	25,5	20,0	21,0	16,7	-	13,9	-	-	-	-	-	-	-	-	-	-	30,0
32,0	-	32,0	30,5	30,0	25,5	20,0	21,0	16,7	17,4	13,9	-	11,4	-	-	-	-	-	-	-	-	32,0
34,0	-	30,5	29,0	28,5	25,5	20,0	21,0	16,7	17,4	13,9	-	11,4	-	9,0	-	-	-	-	-	-	34,0
36,0	-	28,5	27,5	26,5	25,5	20,0	21,0	16,7	17,4	13,9	13,3	11,4	-	9,0	-	-	-	-	-	-	36,0
38,0	-	-	26,0	25,5	24,5	20,0	21,0	16,7	17,4	13,9	12,9	11,4	-	9,0	-	-	-	-	-	-	38,0
40,0	-	-	25,0	24,0	23,5	20,0	21,0	16,7	17,4	13,9	12,5	11,4	9,5	9,0	-	-	-	-	-	-	40,0
42,0	-	-	23,0	23,0	22,0	20,0	21,0	16,7	17,3	13,9	12,2	11,4	9,3	9,0	42,0	-	-	-	-	-	42,0
44,0	-	-	-	22,0	21,0	20,0	20,5	16,7	17,2	13,9	12,0	11,4	9,1	9,0	44,0	-	-	-	-	-	44,0
46,0	-	-	-	21,5	20,0	19,5	19,5	16,7	17,1	13,9	11,8	11,3	8,9	9,0	46,0	-	-	-	-	-	46,0
48,0	-	-	-	-	19,4	18,6	18,6	16,7	16,9	13,9	11,6	10,9	8,7	8,9	48,0	-	-	-	-	-	48,0
50,0	-	-	-	-	18,7	17,8	17,8	16,7	16,9	13,9	11,4	10,6	8,5	8,6	50,0	-	-	-	-	-	50,0
52,0	-	-	-	-	18,1	17,1	17,0	16,6	16,5	13,6	11,2	10,3	8,3	8,3	52,0	-	-	-	-	-	52,0
54,0	-	-	-	-	-	16,4	16,4	15,9	15,8	13,2	11,0	10,0	8,2	8,1	54,0	-	-	-	-	-	54,0
56,0	-	-	-	-	-	15,9	15,8	15,2	15,1	12,7	10,9	9,7	8,0	7,8	56,0	-	-	-	-	-	56,0
58,0	-	-	-	-	-	15,3	-	14,7	14,6	12,3	10,8	9,5	7,9	7,6	58,0	-	-	-	-	-	58,0
60,0	-	-	-	-	-	-	-	14,1	14,0	12,0	10,7	9,2	7,7	7,3	60,0	-	-	-	-	-	60,0
62,0	-	-	-	-	-	-	-	13,7	13,6	11,7	10,6	8,9	7,6	7,1	62,0	-	-	-	-	-	62,0
64,0	-	-	-	-	-	-	-	13,2	-	11,5	10,5	8,7	7,5	6,9	64,0	-	-	-	-	-	64,0
66,0	-	-	-	-	-	-	-	-	-	11,2	10,5	8,4	7,5	6,7	66,0	-	-	-	-	-	66,0
68,0	-	-	-	-	-	-	-	-	-	11,0	10,5	8,2	7,4	6,5	68,0	-	-	-	-	-	68,0
70,0	-	-	-	-	-	-	-	-	-	10,7	-	8,0	7,3	6,3	70,0	-	-	-	-	-	70,0
72,0	-	-	-	-	-	-	-	-	-	-	-	7,8	7,3	6,1	72,0	-	-	-	-	-	72,0
74,0	-	-	-	-	-	-	-	-	-	-	-	7,6	7,3	5,9	74,0	-	-	-	-	-	74,0
76,0	-	-	-	-	-	-	-	-	-	-	-	7,4	-	5,8	76,0	-	-	-	-	-	76,0
78,0	-	-	-	-	-	-	-	-	-	-	-	-	-	5,6	78,0	-	-	-	-	-	78,0
80,0	-	-	-	-	-	-	-	-	-	-	-	-	-	5,5	80,0	-	-	-	-	-	80,0
82,0	-	-	-	-	-	-	-	-	-	-	-	-	-	5,3	82,0	-	-	-	-	-	82,0

Load charts • Traglasten • Capacités de levage Capacidades • Capacità • Таблицы грузоподъемности

MEGAWINGLIFT

Luffing jib • Wippspitzenausleger • Volée variable • Plumín de angulación variable • Jib a volata variable • Маневровый гусек



80°
39,89 m



0 - 22°
25 - 79 m



8,5 m



360°



135 t



EN 13000

m	25,00		31,00		37,00		43,00		49,00		55,00		61,00		67,00		73,00		79,00		m
	0°	0°	0°	0°	0°	0°	22°	0°	22°	0°	22°	0°	22°	0°	22°	0°	22°	0°	22°		
18,0	51,5	-	-	-	-	-	-	-	-	-	-	-	-	-	-	-	-	-	-	-	18,0
20,0	47,0	46,0	-	-	-	-	-	-	-	-	-	-	-	-	-	-	-	-	-	-	20,0
22,0	43,0	42,5	37,5	-	-	-	-	-	-	-	-	-	-	-	-	-	-	-	-	-	22,0
24,0	40,0	39,0	37,5	30,5	-	-	-	-	-	-	-	-	-	-	-	-	-	-	-	-	24,0
26,0	37,5	36,5	36,0	30,5	25,0	-	-	-	-	-	-	-	-	-	-	-	-	-	-	-	26,0
28,0	35,0	34,0	33,5	30,5	25,0	20,0	-	-	-	-	-	-	-	-	-	-	-	-	-	-	28,0
30,0	33,5	32,0	31,5	30,5	25,0	20,0	20,5	16,6	-	-	-	-	-	-	-	-	-	-	-	-	30,0
32,0	-	30,0	29,5	28,5	25,0	20,0	20,5	16,6	-	13,9	-	-	-	-	-	-	-	-	-	-	32,0
34,0	-	28,5	28,0	27,0	25,0	20,0	20,5	16,6	17,3	13,9	-	11,4	-	9,2	-	-	-	-	-	-	34,0
36,0	-	27,5	26,5	25,5	25,0	20,0	20,5	16,6	17,3	13,9	-	11,4	-	9,2	-	-	-	-	-	-	36,0
38,0	-	-	25,0	24,0	23,5	20,0	20,5	16,6	17,3	13,9	13,0	11,4	-	9,2	-	-	-	-	-	-	38,0
40,0	-	-	24,0	23,0	22,0	20,0	20,5	16,6	17,3	13,9	12,7	11,4	-	9,2	-	-	-	-	-	-	40,0
42,0	-	-	23,0	21,5	21,0	20,0	20,5	16,6	17,2	13,9	12,3	11,4	9,4	9,2	-	-	-	-	-	-	42,0
44,0	-	-	-	21,0	20,0	19,5	19,5	16,6	17,1	13,9	12,1	11,4	9,2	9,2	-	-	-	-	-	-	44,0
46,0	-	-	-	20,0	19,1	18,5	18,5	16,6	17,0	13,9	11,9	11,3	9,0	9,2	-	-	-	-	-	-	46,0
48,0	-	-	-	19,5	18,3	17,6	17,6	16,6	16,9	13,9	11,6	11,0	8,8	9,0	-	-	-	-	-	-	48,0
50,0	-	-	-	-	17,6	16,8	16,8	16,4	16,3	13,9	11,5	10,7	8,6	8,7	-	-	-	-	-	-	50,0
52,0	-	-	-	-	17,0	16,1	16,1	15,7	15,6	13,8	11,3	10,4	8,4	8,4	-	-	-	-	-	-	52,0
54,0	-	-	-	-	16,6	15,5	15,4	15,0	14,9	13,4	11,1	10,1	8,2	8,2	-	-	-	-	-	-	54,0
56,0	-	-	-	-	-	14,9	14,9	14,3	14,2	12,9	10,9	9,8	8,1	7,9	-	-	-	-	-	-	56,0
58,0	-	-	-	-	-	14,4	14,4	13,8	13,7	12,5	10,8	9,6	7,9	7,7	-	-	-	-	-	-	58,0
60,0	-	-	-	-	-	14,1	-	13,2	13,1	12,2	10,7	9,3	7,8	7,4	-	-	-	-	-	-	60,0
62,0	-	-	-	-	-	-	-	12,8	12,7	11,9	10,6	9,0	7,7	7,2	-	-	-	-	-	-	62,0
64,0	-	-	-	-	-	-	-	12,4	12,3	11,6	10,6	8,8	7,6	7,0	-	-	-	-	-	-	64,0
66,0	-	-	-	-	-	-	-	12,2	-	11,4	10,5	8,6	7,5	6,8	-	-	-	-	-	-	66,0
68,0	-	-	-	-	-	-	-	-	-	11,1	10,5	8,3	7,4	6,6	-	-	-	-	-	-	68,0
70,0	-	-	-	-	-	-	-	-	-	10,8	10,5	8,1	7,4	6,4	-	-	-	-	-	-	70,0
72,0	-	-	-	-	-	-	-	-	-	10,3	-	7,9	7,3	6,2	-	-	-	-	-	-	72,0
74,0	-	-	-	-	-	-	-	-	-	-	-	7,7	7,3	6,0	-	-	-	-	-	-	74,0
76,0	-	-	-	-	-	-	-	-	-	-	-	7,5	7,3	5,9	-	-	-	-	-	-	76,0
78,0	-	-	-	-	-	-	-	-	-	-	-	7,3	-	5,7	-	-	-	-	-	-	78,0
80,0	-	-	-	-	-	-	-	-	-	-	-	-	-	5,6	-	-	-	-	-	-	80,0
82,0	-	-	-	-	-	-	-	-	-	-	-	-	-	5,4	-	-	-	-	-	-	82,0

Load charts • Traglasten • Capacités de levage Capacidades • Capacità • Таблицы грузоподъемности

MEGAWINGLIFT

Luffing jib • Wippspitzenausleger • Volée variable • Plumín de angulación variable • Jib a volata variable • Маневровый гусек



80°
44,79 m



0 - 22°
25 - 79 m



8,5 m



360°



135 t



EN 13000

m	25,00		31,00		37,00		43,00		49,00		55,00		61,00		67,00		73,00		79,00		m
	0°	0°	0°	0°	0°	0°	0°	22°	0°	22°	0°	22°	0°	22°	0°	22°	0°	22°	0°		
18,0	49,5	-	-	-	-	-	-	-	-	-	-	-	-	-	-	-	-	-	-	-	18,0
20,0	45,0	44,0	-	-	-	-	-	-	-	-	-	-	-	-	-	-	-	-	-	-	20,0
22,0	41,5	41,0	35,5	-	-	-	-	-	-	-	-	-	-	-	-	-	-	-	-	-	22,0
24,0	38,5	37,5	35,5	29,0	-	-	-	-	-	-	-	-	-	-	-	-	-	-	-	-	24,0
26,0	35,5	35,0	34,5	29,0	24,0	-	-	-	-	-	-	-	-	-	-	-	-	-	-	-	26,0
28,0	33,5	32,5	32,0	29,0	24,0	19,8	-	-	-	-	-	-	-	-	-	-	-	-	-	-	28,0
30,0	31,5	30,5	30,0	29,0	24,0	19,8	19,9	16,6	-	-	-	-	-	-	-	-	-	-	-	-	30,0
32,0	30,5	29,0	28,0	27,5	24,0	19,8	19,9	16,6	-	13,8	-	-	-	-	-	-	-	-	-	-	32,0
34,0	-	27,5	26,5	26,0	24,0	19,8	19,9	16,6	16,8	13,8	-	11,3	-	-	-	-	-	-	-	-	34,0
36,0	-	26,0	25,0	24,5	24,0	19,8	19,9	16,6	16,8	13,8	-	11,3	-	9,4	-	-	-	-	-	-	36,0
38,0	-	25,5	24,0	23,0	22,5	19,8	19,9	16,6	16,8	13,8	13,2	11,3	-	9,4	-	-	-	-	-	-	38,0
40,0	-	-	22,5	22,0	21,5	19,8	19,9	16,6	16,8	13,8	12,8	11,3	-	9,4	-	-	-	-	-	-	40,0
42,0	-	-	22,0	20,5	20,5	19,6	19,6	16,6	16,8	13,8	12,4	11,3	9,5	9,4	-	-	-	-	-	-	42,0
44,0	-	-	21,5	19,7	19,3	18,6	18,5	16,6	16,8	13,8	12,1	11,3	9,3	9,4	-	-	-	-	-	-	44,0
46,0	-	-	-	18,9	18,4	17,6	17,6	16,6	16,8	13,8	11,9	11,3	9,1	9,4	-	-	-	-	-	-	46,0
48,0	-	-	-	18,3	17,6	16,8	16,7	16,4	16,3	13,8	11,7	11,1	8,9	9,1	-	-	-	-	-	-	48,0
50,0	-	-	-	17,9	16,8	16,0	15,9	15,6	15,5	13,8	11,5	10,8	8,7	8,8	-	-	-	-	-	-	50,0
52,0	-	-	-	-	16,2	15,3	15,2	14,8	14,8	13,8	11,3	10,5	8,5	8,6	-	-	-	-	-	-	52,0
54,0	-	-	-	-	15,7	14,6	14,6	14,2	14,1	13,5	11,2	10,2	8,3	8,3	-	-	-	-	-	-	54,0
56,0	-	-	-	-	-	14,0	14,0	13,5	13,5	13,1	11,0	10,0	8,1	8,0	-	-	-	-	-	-	56,0
58,0	-	-	-	-	-	13,5	13,5	13,0	12,9	12,6	10,9	9,7	8,0	7,8	-	-	-	-	-	-	58,0
60,0	-	-	-	-	-	13,1	-	12,5	12,4	12,1	10,8	9,4	7,9	7,5	-	-	-	-	-	-	60,0
62,0	-	-	-	-	-	-	-	12,0	11,9	11,6	10,7	9,2	7,7	7,3	-	-	-	-	-	-	62,0
64,0	-	-	-	-	-	-	-	11,6	11,5	11,1	10,6	8,9	7,6	7,1	-	-	-	-	-	-	64,0
66,0	-	-	-	-	-	-	-	11,3	-	10,7	10,5	8,6	7,5	6,9	-	-	-	-	-	-	66,0
68,0	-	-	-	-	-	-	-	-	-	10,3	10,2	8,4	7,5	6,7	-	-	-	-	-	-	68,0
70,0	-	-	-	-	-	-	-	-	-	10,0	9,9	8,2	7,4	6,4	-	-	-	-	-	-	70,0
72,0	-	-	-	-	-	-	-	-	-	9,8	-	8,0	7,3	6,3	-	-	-	-	-	-	72,0
74,0	-	-	-	-	-	-	-	-	-	-	-	7,8	7,3	6,1	-	-	-	-	-	-	74,0
76,0	-	-	-	-	-	-	-	-	-	-	-	7,7	7,3	5,9	-	-	-	-	-	-	76,0
78,0	-	-	-	-	-	-	-	-	-	-	-	7,5	-	5,8	-	-	-	-	-	-	78,0
80,0	-	-	-	-	-	-	-	-	-	-	-	-	-	5,6	-	-	-	-	-	-	80,0
82,0	-	-	-	-	-	-	-	-	-	-	-	-	-	5,5	-	-	-	-	-	-	82,0
84,0	-	-	-	-	-	-	-	-	-	-	-	-	-	5,3	-	-	-	-	-	-	84,0

Load charts • Traglasten • Capacités de levage Capacidades • Capacità • Таблицы грузоподъемности

MEGAWINGLIFT

Luffing jib • Wippspitzenausleger • Volée variable • Plumín de angulación variable • Jib a volata variable • Маневровый гусек



80°
49,69 m



0 - 22°
25 - 79 m



8,5 m



360°



135 t



EN 13000

m	25,00		31,00		37,00		43,00		49,00		55,00		61,00		67,00		73,00		79,00		m
	0°	0°	0°	0°	0°	0°	0°	22°	0°	22°	0°	22°	0°	22°	0°	22°	0°	22°	0°		
20,0	43,0	-	-	-	-	-	-	-	-	-	-	-	-	-	-	-	-	-	-	-	20,0
22,0	39,5	39,0	-	-	-	-	-	-	-	-	-	-	-	-	-	-	-	-	-	-	22,0
24,0	36,5	36,0	34,0	-	-	-	-	-	-	-	-	-	-	-	-	-	-	-	-	-	24,0
26,0	34,0	33,5	33,0	28,0	-	-	-	-	-	-	-	-	-	-	-	-	-	-	-	-	26,0
28,0	31,5	31,5	31,0	28,0	23,0	-	-	-	-	-	-	-	-	-	-	-	-	-	-	-	28,0
30,0	30,0	29,5	29,0	28,0	23,0	18,8	-	-	-	-	-	-	-	-	-	-	-	-	-	-	30,0
32,0	28,5	27,5	27,0	26,5	23,0	18,8	19,1	15,9	-	-	-	-	-	-	-	-	-	-	-	-	32,0
34,0	27,5	26,0	25,5	24,5	23,0	18,8	19,1	15,9	-	13,5	-	-	-	-	-	-	-	-	-	-	34,0
36,0	-	24,5	24,0	23,5	23,0	18,8	19,1	15,9	16,0	13,5	-	11,2	-	9,4	-	-	-	-	-	-	36,0
38,0	-	23,5	22,5	22,0	21,5	18,8	19,1	15,9	16,0	13,5	-	11,2	-	9,4	-	-	-	-	-	-	38,0
40,0	-	-	21,5	21,0	20,5	18,8	19,1	15,9	16,0	13,5	12,9	11,2	-	9,4	-	-	-	-	-	-	40,0
42,0	-	-	20,5	19,7	19,4	18,7	18,7	15,9	16,0	13,5	12,5	11,2	-	9,4	-	-	-	-	-	-	42,0
44,0	-	-	19,9	18,8	18,4	17,7	17,7	15,9	16,0	13,5	12,2	11,2	9,3	9,4	-	-	-	-	-	-	44,0
46,0	-	-	-	18,0	17,5	16,8	16,8	15,9	16,0	13,5	11,9	11,2	9,1	9,4	-	-	-	-	-	-	46,0
48,0	-	-	-	17,3	16,7	16,0	16,0	15,6	15,6	13,5	11,7	11,1	8,9	9,1	-	-	-	-	-	-	48,0
50,0	-	-	-	16,7	16,0	15,2	15,2	14,8	14,8	13,5	11,6	10,8	8,7	8,9	-	-	-	-	-	-	50,0
52,0	-	-	-	-	15,3	14,5	14,5	14,1	14,0	13,5	11,4	10,6	8,6	8,6	-	-	-	-	-	-	52,0
54,0	-	-	-	-	14,8	13,9	13,8	13,4	13,4	13,1	11,2	10,3	8,4	8,4	-	-	-	-	-	-	54,0
56,0	-	-	-	-	14,3	13,3	13,2	12,8	12,8	12,5	11,1	10,1	8,2	8,1	-	-	-	-	-	-	56,0
58,0	-	-	-	-	-	12,8	12,7	12,3	12,2	11,9	10,9	9,8	8,1	7,9	-	-	-	-	-	-	58,0
60,0	-	-	-	-	-	12,3	12,3	11,8	11,7	11,4	10,8	9,5	7,9	7,6	-	-	-	-	-	-	60,0
62,0	-	-	-	-	-	12,0	-	11,3	11,2	10,9	10,7	9,3	7,8	7,4	-	-	-	-	-	-	62,0
64,0	-	-	-	-	-	-	-	10,9	10,8	10,5	10,4	9,0	7,7	7,2	-	-	-	-	-	-	64,0
66,0	-	-	-	-	-	-	-	10,5	10,5	10,0	10,0	8,8	7,6	7,0	-	-	-	-	-	-	66,0
68,0	-	-	-	-	-	-	-	10,3	-	9,7	9,6	8,6	7,5	6,8	-	-	-	-	-	-	68,0
70,0	-	-	-	-	-	-	-	-	-	9,3	9,3	8,3	7,4	6,6	-	-	-	-	-	-	70,0
72,0	-	-	-	-	-	-	-	-	-	9,0	9,0	8,1	7,4	6,4	-	-	-	-	-	-	72,0
74,0	-	-	-	-	-	-	-	-	-	8,9	-	7,9	7,3	6,2	-	-	-	-	-	-	74,0
76,0	-	-	-	-	-	-	-	-	-	-	-	7,7	7,3	6,0	-	-	-	-	-	-	76,0
78,0	-	-	-	-	-	-	-	-	-	-	-	7,6	7,3	5,9	-	-	-	-	-	-	78,0
80,0	-	-	-	-	-	-	-	-	-	-	-	7,4	-	5,7	-	-	-	-	-	-	80,0
82,0	-	-	-	-	-	-	-	-	-	-	-	-	-	5,6	-	-	-	-	-	-	82,0
84,0	-	-	-	-	-	-	-	-	-	-	-	-	-	5,4	-	-	-	-	-	-	84,0

Load charts • Traglasten • Capacités de levage Capacidades • Capacità • Таблицы грузоподъемности

MEGAWINGLIFT

Luffing jib • Wippspitzenausleger • Volée variable • Plumín de angulación variable • Jib a volata variable • Маневровый гусек



80°
54,59 m



0 - 22°
25 - 79 m



8,5 m



360°



135 t



EN 13000

m	25,00		31,00		37,00		43,00		49,00		55,00		61,00		67,00		73,00		79,00		m
	0°	0°	0°	0°	0°	0°	0°	22°	0°	22°	0°	22°	0°	22°	0°	22°	0°	22°	0°		
22,0	38,0	-	-	-	-	-	-	-	-	-	-	-	-	-	-	-	-	-	-	-	22,0
24,0	35,0	34,5	-	-	-	-	-	-	-	-	-	-	-	-	-	-	-	-	-	-	24,0
26,0	32,5	32,0	32,0	-	-	-	-	-	-	-	-	-	-	-	-	-	-	-	-	-	26,0
28,0	30,5	30,0	29,5	26,0	-	-	-	-	-	-	-	-	-	-	-	-	-	-	-	-	28,0
30,0	28,5	28,0	27,5	26,0	21,5	-	-	-	-	-	-	-	-	-	-	-	-	-	-	-	30,0
32,0	27,0	26,5	26,0	25,0	21,5	17,8	18,0	-	-	-	-	-	-	-	-	-	-	-	-	-	32,0
34,0	25,5	25,0	24,5	23,5	21,5	17,8	18,0	15,1	-	-	-	-	-	-	-	-	-	-	-	-	34,0
36,0	-	23,5	23,0	22,5	21,5	17,8	18,0	15,1	-	12,8	-	-	-	-	-	-	-	-	-	-	36,0
38,0	-	22,5	21,5	21,0	21,0	17,8	18,0	15,1	15,2	12,8	-	10,6	-	8,9	-	-	-	-	-	-	38,0
40,0	-	21,5	20,5	19,9	19,6	17,8	18,0	15,1	15,2	12,8	-	10,6	-	8,9	-	-	-	-	-	-	40,0
42,0	-	-	19,6	18,8	18,6	17,8	17,9	15,1	15,2	12,8	12,2	10,6	-	8,9	-	-	-	-	-	-	42,0
44,0	-	-	18,8	17,9	17,6	16,9	16,9	15,1	15,2	12,8	12,0	10,6	-	8,9	-	-	-	-	-	-	44,0
46,0	-	-	18,2	17,1	16,7	16,0	16,0	15,1	15,2	12,8	11,9	10,6	-	8,9	-	-	-	-	-	-	46,0
48,0	-	-	-	16,3	15,9	15,2	15,2	14,9	14,8	12,8	11,7	10,6	9,0	8,9	-	-	-	-	-	-	48,0
50,0	-	-	-	15,7	15,2	14,5	14,4	14,1	14,1	12,8	11,5	10,6	8,8	8,9	-	-	-	-	-	-	50,0
52,0	-	-	-	15,2	14,6	13,8	13,7	13,4	13,3	12,8	11,4	10,5	8,6	8,6	-	-	-	-	-	-	52,0
54,0	-	-	-	-	14,0	13,1	13,1	12,7	12,7	12,4	11,2	10,3	8,5	8,4	-	-	-	-	-	-	54,0
56,0	-	-	-	-	13,5	12,6	12,5	12,1	12,1	11,8	11,1	10,1	8,3	8,2	-	-	-	-	-	-	56,0
58,0	-	-	-	-	13,1	12,0	12,0	11,6	11,5	11,3	11,0	9,9	8,1	8,0	-	-	-	-	-	-	58,0
60,0	-	-	-	-	-	11,6	11,5	11,1	11,0	10,8	10,8	9,6	8,0	7,7	-	-	-	-	-	-	60,0
62,0	-	-	-	-	-	11,2	11,1	10,6	10,6	10,3	10,5	9,4	7,9	7,5	-	-	-	-	-	-	62,0
64,0	-	-	-	-	-	10,9	-	10,2	10,1	9,8	10,1	9,1	7,7	7,3	-	-	-	-	-	-	64,0
66,0	-	-	-	-	-	-	-	9,8	9,8	9,4	9,6	8,9	7,6	7,1	-	-	-	-	-	-	66,0
68,0	-	-	-	-	-	-	-	9,5	9,4	9,0	9,2	8,7	7,5	6,9	-	-	-	-	-	-	68,0
70,0	-	-	-	-	-	-	-	9,3	-	8,7	8,9	8,5	7,5	6,7	-	-	-	-	-	-	70,0
72,0	-	-	-	-	-	-	-	-	-	8,4	8,6	-	7,4	6,5	-	-	-	-	-	-	72,0
74,0	-	-	-	-	-	-	-	-	-	8,1	8,3	-	7,3	6,3	-	-	-	-	-	-	74,0
76,0	-	-	-	-	-	-	-	-	-	8,0	-	-	7,3	6,1	-	-	-	-	-	-	76,0
78,0	-	-	-	-	-	-	-	-	-	-	-	-	7,2	6,0	-	-	-	-	-	-	78,0
80,0	-	-	-	-	-	-	-	-	-	-	-	-	7,0	5,8	-	-	-	-	-	-	80,0
82,0	-	-	-	-	-	-	-	-	-	-	-	-	-	5,7	-	-	-	-	-	-	82,0
84,0	-	-	-	-	-	-	-	-	-	-	-	-	-	5,5	-	-	-	-	-	-	84,0
86,0	-	-	-	-	-	-	-	-	-	-	-	-	-	5,4	-	-	-	-	-	-	86,0

Load charts • Traglasten • Capacités de levage Capacidades • Capacità • Таблицы грузоподъемности

MEGAWINGLIFT

Luffing jib • Wippspitzenausleger • Volée variable • Plumín de angulación variable • Jib a volata variable • Маневровый гусек



70°
34,99 m



0 - 22°
25 - 79 m



8,5 m



360°



135 t



EN 13000

m	25,00		31,00		37,00		43,00		49,00		55,00		61,00		67,00		73,00		79,00		m
	0°	0°	0°	0°	0°	0°	0°	22°	0°	22°	0°	22°	0°	22°	0°	22°	0°	22°	0°		
26,0	37,5	-	-	-	-	-	-	-	-	-	-	-	-	-	-	-	-	-	-	-	26,0
28,0	34,5	-	-	-	-	-	-	-	-	-	-	-	-	-	-	-	-	-	-	-	28,0
30,0	32,0	31,5	-	-	-	-	-	-	-	-	-	-	-	-	-	-	-	-	-	-	30,0
32,0	30,0	29,5	-	-	-	-	-	-	-	-	-	-	-	-	-	-	-	-	-	-	32,0
34,0	27,5	27,5	27,0	-	-	-	-	-	-	-	-	-	-	-	-	-	-	-	-	-	34,0
36,0	26,0	25,5	25,5	25,0	-	-	-	-	-	-	-	-	-	-	-	-	-	-	-	-	36,0
38,0	-	24,0	23,5	23,5	-	-	-	-	-	-	-	-	-	-	-	-	-	-	-	-	38,0
40,0	-	22,5	22,5	22,0	21,5	-	-	-	-	-	-	-	-	-	-	-	-	-	-	-	40,0
42,0	-	21,0	21,0	20,5	20,5	20,0	-	-	-	-	-	-	-	-	-	-	-	-	-	-	42,0
44,0	-	-	19,8	19,5	19,2	18,8	18,8	-	-	-	-	-	-	-	-	-	-	-	-	-	44,0
46,0	-	-	18,7	18,4	18,1	17,8	17,8	17,5	-	-	-	-	-	-	-	-	-	-	-	-	46,0
48,0	-	-	17,7	17,4	17,1	16,8	16,8	16,5	16,5	14,8	-	-	-	-	-	-	-	-	-	-	48,0
50,0	-	-	-	16,5	16,2	15,9	15,9	15,7	15,7	14,6	-	-	-	-	-	-	-	-	-	-	50,0
52,0	-	-	-	15,7	15,4	15,1	15,1	14,8	14,8	14,3	-	-	-	-	-	-	-	-	-	-	52,0
54,0	-	-	-	14,9	14,6	14,3	14,3	14,1	14,1	13,9	11,5	10,8	-	-	-	-	-	-	-	-	54,0
56,0	-	-	-	-	13,9	13,6	13,6	13,4	13,4	13,2	11,4	10,6	-	-	-	-	-	-	-	-	56,0
58,0	-	-	-	-	13,3	13,0	12,9	12,7	12,7	12,6	11,2	10,3	8,3	-	-	-	-	-	-	-	58,0
60,0	-	-	-	-	12,6	12,3	12,3	12,1	12,1	11,9	11,0	10,0	8,2	7,4	-	-	-	-	-	-	60,0
62,0	-	-	-	-	-	11,8	11,7	11,6	11,6	11,4	10,9	9,7	8,0	7,2	-	-	-	-	-	-	62,0
64,0	-	-	-	-	-	11,2	-	11,0	11,0	10,9	10,8	9,5	7,9	6,9	-	-	-	-	-	-	64,0
66,0	-	-	-	-	-	-	-	10,5	10,5	10,3	10,5	9,2	7,7	6,7	-	-	-	-	-	-	66,0
68,0	-	-	-	-	-	-	-	10,0	10,0	9,9	10,1	8,9	7,6	6,5	-	-	-	-	-	-	68,0
70,0	-	-	-	-	-	-	-	9,6	-	9,4	9,6	8,7	7,5	6,3	-	-	-	-	-	-	70,0
72,0	-	-	-	-	-	-	-	-	-	9,0	9,2	8,5	7,4	6,0	-	-	-	-	-	-	72,0
74,0	-	-	-	-	-	-	-	-	-	8,6	8,8	8,2	7,4	5,8	-	-	-	-	-	-	74,0
76,0	-	-	-	-	-	-	-	-	-	8,2	-	8,0	7,3	5,7	-	-	-	-	-	-	76,0
78,0	-	-	-	-	-	-	-	-	-	-	-	7,7	7,3	5,5	-	-	-	-	-	-	78,0
80,0	-	-	-	-	-	-	-	-	-	-	-	7,3	7,3	5,3	-	-	-	-	-	-	80,0
82,0	-	-	-	-	-	-	-	-	-	-	-	7,0	-	5,2	-	-	-	-	-	-	82,0
84,0	-	-	-	-	-	-	-	-	-	-	-	-	-	5,0	-	-	-	-	-	-	84,0
86,0	-	-	-	-	-	-	-	-	-	-	-	-	-	4,9	-	-	-	-	-	-	86,0



70°
39,89 m



0 - 22°
25 - 79 m



8,5 m



360°



135 t



EN 13000

m	25,00		31,00		37,00		43,00		49,00		55,00		61,00		67,00		73,00		79,00		m
	0°	0°	0°	0°	0°	0°	0°	22°	0°	22°	0°	22°	0°	22°	0°	22°	0°	22°	0°		
26,0	37,5	-	-	-	-	-	-	-	-	-	-	-	-	-	-	-	-	-	-	-	26,0
28,0	34,5	-	-	-	-	-	-	-	-	-	-	-	-	-	-	-	-	-	-	-	28,0
30,0	32,0	-	-	-	-	-	-	-	-	-	-	-	-	-	-	-	-	-	-	-	30,0
32,0	30,0	28,0	-	-	-	-	-	-	-	-	-	-	-	-	-	-	-	-	-	-	32,0
34,0	27,5	26,5	-	-	-	-	-	-	-	-	-	-	-	-	-	-	-	-	-	-	34,0
36,0	26,0	24,5	24,0	-	-	-	-	-	-	-	-	-	-	-	-	-	-	-	-	-	36,0
38,0	-	23,0	22,5	22,0	-	-	-	-	-	-	-	-	-	-	-	-	-	-	-	-	38,0
40,0	-	21,5	21,0	21,0	-	-	-	-	-	-	-	-	-	-	-	-	-	-	-	-	40,0
42,0	-	20,5	20,0	19,6	19,4	-	-	-	-	-	-	-	-	-	-	-	-	-	-	-	42,0
44,0	-	19,1	18,9	18,4	18,3	17,7	-	-	-	-	-	-	-	-	-	-	-	-	-	-	44,0
46,0	-	-	17,8	17,4	17,3	16,7	16,7	-	-	-	-	-	-	-	-	-	-	-	-	-	46,0
48,0	-	-	16,8	16,5	16,3	15,8	15,8	15,4	-	-	-	-	-	-	-	-	-	-	-	-	48,0
50,0	-	-	15,9	15,6	15,5	15,0	15,0	14,6	14,6	14,3	-	-	-	-	-	-	-	-	-	-	50,0
52,0	-	-	-	14,8	14,7	14,2	14,2	13,8	13,8	13,6	-	-	-	-	-	-	-	-	-	-	52,0
54,0	-	-	-	14,0	13,9	13,5	13,4	13,1	13,1	12,9	-	-	-	-	-	-	-	-	-	-	54,0
56,0	-	-	-	13,3	13,2	12,8	12,8	12,5	12,5	12,2	11,5	10,7	-	-	-	-	-	-	-	-	56,0
58,0	-	-	-	-	12,6	12,1	12,1	11,8	11,8	11,6	11,3	10,5	-	-	-	-	-	-	-	-	58,0
60,0	-	-	-	-	12,0	11,6	11,5	11,2	11,3	11,0	11,2	10,2	8,3	7,2	-	-	-	-	-	-	60,0
62,0	-	-	-	-	11,4	11,0	11,0	10,7	10,7	10,4	10,7	10,0	8,1	6,9	-	-	-	-	-	-	62,0
64,0	-	-	-	-	-	10,5	10,5	10,2	10,2	9,9	10,2	9,7	8,0	6,7	-	-	-	-	-	-	64,0
66,0	-	-	-	-	-	10,0	-	9,7	9,7	9,5	9,7	9,4	7,9	6,4	-	-	-	-	-	-	66,0
68,0	-	-	-	-	-	-	-	9,2	9,2	9,0	9,2	8,9	7,7	6,2	-	-	-	-	-	-	68,0
70,0	-	-	-	-	-	-	-	8,8	8,8	8,6	8,8	8,5	7,6	6,0	-	-	-	-	-	-	70,0
72,0	-	-	-	-	-	-	-	8,3	-	8,2	8,4	8,1	7,5	5,8	-	-	-	-	-	-	72,0
74,0	-	-	-	-	-	-	-	-	-	7,8	8,0	7,7	7,4	5,7	-	-	-	-	-	-	74,0
76,0	-	-	-	-	-	-	-	-	-	7,4	7,6	7,3	7,3	5,5	-	-	-	-	-	-	76,0
78,0	-	-	-	-	-	-	-	-	-	7,0	-	7,0	7,0	5,3	-	-	-	-	-	-	78,0
80,0	-	-	-	-	-	-	-	-	-	-	-	6,6	6,6	5,2	-	-	-	-	-	-	80,0
82,0	-	-	-	-	-	-	-	-	-	-	-	6,3	6,3	4,9	-	-	-	-	-	-	82,0
84,0	-	-	-	-	-	-	-	-	-	-	-	6,0	-	4,7	-	-	-	-	-	-	84,0

Load charts • Traglasten • Capacités de levage Capacidades • Capacità • Таблицы грузоподъемности

MEGAWINGLIFT

Luffing jib • Wippspitzenausleger • Volée variable • Plumín de angulación variable • Jib a volata variable • Маневровый гусек



70°
44,79 m



0 - 22°
25 - 79 m



8,5 m



360°



135 t



EN 13000

m	25,00		31,00		37,00		43,00		49,00		55,00		61,00		67,00		73,00		79,00		m
	0°	0°	0°	0°	0°	0°	0°	22°	0°	22°	0°	22°	0°	22°	0°	22°	0°	22°	0°		
30,0	29,0	-	-	-	-	-	-	-	-	-	-	-	-	-	-	-	-	-	-	-	30,0
32,0	27,5	-	-	-	-	-	-	-	-	-	-	-	-	-	-	-	-	-	-	-	32,0
34,0	25,5	25,0	-	-	-	-	-	-	-	-	-	-	-	-	-	-	-	-	-	-	34,0
36,0	24,0	23,5	-	-	-	-	-	-	-	-	-	-	-	-	-	-	-	-	-	-	36,0
38,0	22,0	22,0	21,5	-	-	-	-	-	-	-	-	-	-	-	-	-	-	-	-	-	38,0
40,0	21,0	20,5	20,0	19,7	-	-	-	-	-	-	-	-	-	-	-	-	-	-	-	-	40,0
42,0	-	19,4	19,0	18,6	-	-	-	-	-	-	-	-	-	-	-	-	-	-	-	-	42,0
44,0	-	18,3	17,9	17,5	17,3	-	-	-	-	-	-	-	-	-	-	-	-	-	-	-	44,0
46,0	-	17,2	16,9	16,5	16,4	-	-	-	-	-	-	-	-	-	-	-	-	-	-	-	46,0
48,0	-	-	16,0	15,6	15,5	14,8	14,8	-	-	-	-	-	-	-	-	-	-	-	-	-	48,0
50,0	-	-	15,2	14,8	14,7	14,0	14,0	13,6	-	-	-	-	-	-	-	-	-	-	-	-	50,0
52,0	-	-	14,3	14,0	13,9	13,3	13,2	12,9	-	12,6	-	-	-	-	-	-	-	-	-	-	52,0
54,0	-	-	-	13,3	13,2	12,6	12,6	12,2	12,2	11,9	-	11,1	-	-	-	-	-	-	-	-	54,0
56,0	-	-	-	12,6	12,5	11,9	11,9	11,6	11,6	11,3	-	10,9	-	-	-	-	-	-	-	-	56,0
58,0	-	-	-	12,0	11,9	11,3	11,3	11,0	11,0	10,7	11,0	10,6	-	-	-	-	-	-	-	-	58,0
60,0	-	-	-	-	11,3	10,7	10,7	10,4	10,4	10,1	10,4	10,0	-	-	-	-	-	-	-	-	60,0
62,0	-	-	-	-	10,8	10,2	10,2	9,9	9,9	9,6	9,9	9,5	8,3	-	-	-	-	-	-	-	62,0
64,0	-	-	-	-	10,2	9,7	9,7	9,4	9,4	9,1	9,4	9,0	8,1	7,6	-	-	-	-	-	-	64,0
66,0	-	-	-	-	-	9,2	9,2	8,9	8,9	8,7	8,9	8,6	8,0	7,0	-	-	-	-	-	-	66,0
68,0	-	-	-	-	-	8,7	-	8,5	8,5	8,2	8,5	8,1	7,8	6,8	-	-	-	-	-	-	68,0
70,0	-	-	-	-	-	-	-	8,1	8,1	7,8	8,1	7,7	7,7	6,8	-	-	-	-	-	-	70,0
72,0	-	-	-	-	-	-	-	7,6	7,7	7,4	7,7	7,3	7,4	6,4	-	-	-	-	-	-	72,0
74,0	-	-	-	-	-	-	-	-	7,3	-	7,1	7,3	7,0	7,0	6,1	-	-	-	-	-	74,0
76,0	-	-	-	-	-	-	-	-	-	-	6,7	6,9	6,6	6,7	5,8	-	-	-	-	-	76,0
78,0	-	-	-	-	-	-	-	-	-	-	6,4	6,6	6,3	6,3	5,5	-	-	-	-	-	78,0
80,0	-	-	-	-	-	-	-	-	-	-	6,0	-	6,0	5,2	-	-	-	-	-	-	80,0
82,0	-	-	-	-	-	-	-	-	-	-	-	-	5,6	4,9	-	-	-	-	-	-	82,0
84,0	-	-	-	-	-	-	-	-	-	-	-	-	5,3	4,7	-	-	-	-	-	-	84,0
86,0	-	-	-	-	-	-	-	-	-	-	-	-	5,0	4,4	-	-	-	-	-	-	86,0
88,0	-	-	-	-	-	-	-	-	-	-	-	-	-	4,2	-	-	-	-	-	-	88,0
90,0	-	-	-	-	-	-	-	-	-	-	-	-	-	4,0	-	-	-	-	-	-	90,0



70°
49,69 m



0 - 22°
25 - 79 m



8,5 m



360°



135 t



EN 13000

m	25,00		31,00		37,00		43,00		49,00		55,00		61,00		67,00		73,00		79,00		m
	0°	0°	0°	0°	0°	0°	22°	0°	22°	0°	22°	0°	22°	0°	22°	0°	22°	0°			
34,0	24,5	-	-	-	-	-	-	-	-	-	-	-	-	-	-	-	-	-	-	-	34,0
36,0	23,0	22,5	-	-	-	-	-	-	-	-	-	-	-	-	-	-	-	-	-	-	36,0
38,0	21,5	21,0	-	-	-	-	-	-	-	-	-	-	-	-	-	-	-	-	-	-	38,0
40,0	20,0	19,7	19,2	-	-	-	-	-	-	-	-	-	-	-	-	-	-	-	-	-	40,0
42,0	18,9	18,6	18,1	-	-	-	-	-	-	-	-	-	-	-	-	-	-	-	-	-	42,0
44,0	-	17,5	17,1	16,7	-	-	-	-	-	-	-	-	-	-	-	-	-	-	-	-	44,0
46,0	-	16,5	16,1	15,8	15,4	-	-	-	-	-	-	-	-	-	-	-	-	-	-	-	46,0
48,0	-	15,5	15,2	14,9	14,6	-	-	-	-	-	-	-	-	-	-	-	-	-	-	-	48,0
50,0	-	-	14,4	14,1	13,8	13,1	13,1	-	-	-	-	-	-	-	-	-	-	-	-	-	50,0
52,0	-	-	13,7	13,4	13,1	12,4	12,4	12,0	-	-	-	-	-	-	-	-	-	-	-	-	52,0
54,0	-	-	12,9	12,7	12,4	11,7	11,7	11,4	-	11,0	-	-	-	-	-	-	-	-	-	-	54,0
56,0	-	-	-	12,0	11,8	11,1	11,1	10,7	10,7	10,4	-	-	-	-	-	-	-	-	-	-	56,0
58,0	-	-	-	11,4	11,2	10,5	10,5	10,2	10,2	9,9	-	9,8	-	-	-	-	-	-	-	-	58,0
60,0	-	-	-	10,8	10,6	10,0	10,0	9,6	9,6	9,3	9,6	9,2	-	-	-	-	-	-	-	-	60,0
62,0	-	-	-	-	10,1	9,5	9,5	9,1	9,1	8,8	9,1	8,7	-	6,7	-	-	-	-	-	-	62,0
64,0	-	-	-	-	9,6	9,0	9,0	8,7	8,7	8,4	8,6	8,3	-	6,7	-	-	-	-	-	-	64,0
66,0	-	-	-	-	9,1	8,5	8,5	8,2	8,2	7,9	8,2	7,8	7,9	6,7	-	-	-	-	-	-	66,0
68,0	-	-	-	-	-	8,1	8,1	7,8	7,8	7,5	7,8	7,4	7,5	6,5	-	-	-	-	-	-	68,0
70,0	-	-	-	-	-	7,7	-	7,4	7,4	7,1	7,4	7,0	7,1	6,1	-	-	-	-	-	-	70,0
72,0	-	-	-	-	-	-	-	7,0	7,0	6,8	7,0	6,7	6,7	5,8	-	-	-	-	-	-	72,0
74,0	-	-	-	-	-	-	-	6,6	6,6	6,4	6,6	6,3	6,4	5,5	-	-	-	-	-	-	74,0
76,0	-	-	-	-	-	-	-	6,3	-	6,1	6,3	6,0	6,0	5,2	-	-	-	-	-	-	76,0
78,0	-	-	-	-	-	-	-	-	-	5,7	5,6	5,7	5,7	4,9	-	-	-	-	-	-	78,0
80,0	-	-	-	-	-	-	-	-	-	5,4	5,3	5,3	5,4	4,7	-	-	-	-	-	-	80,0
82,0	-	-	-	-	-	-	-	-	-	5,1	-	5,1	5,1	4,4	-	-	-	-	-	-	82,0
84,0	-	-	-	-	-	-	-	-	-	-	-	4,8	4,8	4,2	-	-	-	-	-	-	84,0
86,0	-	-	-	-	-	-	-	-	-	-	-	4,5	4,5	3,9	-	-	-	-	-	-	86,0
88,0	-	-	-	-	-	-	-	-	-	-	-	4,2	-	3,7	-	-	-	-	-	-	88,0
90,0	-	-	-	-	-	-	-	-	-	-	-	-	-	3,5	-	-	-	-	-	-	90,0
92,0	-	-	-	-	-	-	-	-	-	-	-	-	-	3,3	-	-	-	-	-	-	92,0

Load charts • Traglasten • Capacités de levage Capacidades • Capacità • Таблицы грузоподъемности

MEGAWINGLIFT

Luffing jib • Wippspitzenausleger • Volée variable • Plumín de angulación variable • Jib a volata variable • Маневровый гусек



70°
54,59 m



0 - 22°
25 - 79 m



8,5 m



360°



135 t



EN 13000

m	25,00		31,00		37,00		43,00		49,00		55,00		61,00		67,00		73,00		79,00		m
	0°	0°	0°	0°	0°	0°	0°	22°	0°	22°	0°	22°	0°	22°	0°	22°	0°	22°	0°		
36,0	21,5	-	-	-	-	-	-	-	-	-	-	-	-	-	-	-	-	-	-	-	36,0
38,0	20,5	19,8	-	-	-	-	-	-	-	-	-	-	-	-	-	-	-	-	-	-	38,0
40,0	19,3	18,7	-	-	-	-	-	-	-	-	-	-	-	-	-	-	-	-	-	-	40,0
42,0	18,1	17,6	17,0	-	-	-	-	-	-	-	-	-	-	-	-	-	-	-	-	-	42,0
44,0	17,0	16,6	16,1	-	-	-	-	-	-	-	-	-	-	-	-	-	-	-	-	-	44,0
46,0	-	15,7	15,2	14,8	-	-	-	-	-	-	-	-	-	-	-	-	-	-	-	-	46,0
48,0	-	14,8	14,4	14,0	-	-	-	-	-	-	-	-	-	-	-	-	-	-	-	-	48,0
50,0	-	14,0	13,6	13,2	12,8	-	-	-	-	-	-	-	-	-	-	-	-	-	-	-	50,0
52,0	-	-	12,9	12,5	12,1	11,6	-	-	-	-	-	-	-	-	-	-	-	-	-	-	52,0
54,0	-	-	12,2	11,9	11,5	11,0	11,0	-	-	-	-	-	-	-	-	-	-	-	-	-	54,0
56,0	-	-	11,5	11,3	10,9	10,4	10,4	10,0	-	-	-	-	-	-	-	-	-	-	-	-	56,0
58,0	-	-	-	10,7	10,3	9,8	9,8	9,4	9,4	9,4	-	-	-	-	-	-	-	-	-	-	58,0
60,0	-	-	-	10,1	9,8	9,3	9,3	8,9	8,9	8,9	-	-	-	-	-	-	-	-	-	-	60,0
62,0	-	-	-	9,6	9,3	8,8	8,8	8,4	8,4	8,4	-	-	-	-	-	-	8,0	-	-	-	62,0
64,0	-	-	-	-	8,8	8,3	8,3	8,0	8,0	8,0	8,0	8,0	7,6	-	-	7,6	-	-	7,1	-	64,0
66,0	-	-	-	-	8,3	7,9	7,9	7,5	7,5	7,5	7,6	7,6	7,2	-	-	7,2	-	-	6,7	-	66,0
68,0	-	-	-	-	7,9	7,5	7,5	7,1	7,2	7,2	7,2	7,2	6,8	-	-	6,8	-	-	6,4	-	68,0
70,0	-	-	-	-	-	7,1	7,1	6,8	6,8	6,8	6,8	6,8	6,4	6,4	6,4	6,4	6,4	6,0	6,0	6,0	70,0
72,0	-	-	-	-	-	6,7	6,7	6,4	6,4	6,4	6,4	6,4	6,0	6,0	6,0	6,0	6,0	5,7	5,7	5,7	72,0
74,0	-	-	-	-	-	6,3	-	6,0	6,1	6,1	6,1	6,1	5,7	5,7	5,7	5,7	5,7	5,3	5,3	5,3	74,0
76,0	-	-	-	-	-	-	-	5,7	5,7	5,7	5,7	5,8	5,4	5,4	5,4	5,4	5,4	5,0	5,0	5,0	76,0
78,0	-	-	-	-	-	-	-	5,4	5,4	5,4	5,4	5,4	5,1	5,1	5,1	5,1	5,1	4,7	4,7	4,7	78,0
80,0	-	-	-	-	-	-	-	-	-	-	-	5,1	5,1	4,8	4,8	4,8	4,8	4,4	4,4	4,4	80,0
82,0	-	-	-	-	-	-	-	-	-	-	-	4,8	4,8	4,5	4,5	4,5	4,5	4,2	4,2	4,2	82,0
84,0	-	-	-	-	-	-	-	-	-	-	-	4,5	4,5	4,2	4,2	4,2	4,2	3,9	3,9	3,9	84,0
86,0	-	-	-	-	-	-	-	-	-	-	-	-	-	4,0	4,0	4,0	4,0	3,6	3,6	3,6	86,0
88,0	-	-	-	-	-	-	-	-	-	-	-	-	-	-	-	3,7	3,7	3,4	3,4	3,4	88,0
90,0	-	-	-	-	-	-	-	-	-	-	-	-	-	-	-	-	-	3,2	3,2	3,2	90,0
92,0	-	-	-	-	-	-	-	-	-	-	-	-	-	-	-	-	-	-	-	2,9	92,0
94,0	-	-	-	-	-	-	-	-	-	-	-	-	-	-	-	-	-	-	-	2,7	94,0
96,0	-	-	-	-	-	-	-	-	-	-	-	-	-	-	-	-	-	-	-	2,5	96,0

Load charts • Traglasten • Capacités de levage Capacidades • Capacità • Таблицы грузоподъемности

MEGAWINGLIFT

Luffing jib • Wippspitzenausleger • Volée variable • Plumín de angulación variable • Jib a volata variable • Маневровый гусек



60°
34,99 m



0 - 22°
25 - 67 m



8,5 m



360°



135 t



EN 13000

m	25,00		31,00		37,00		43,00		49,00		55,00		61,00		67,00		m
	0°	0°	0°	0°	0°	0°	0°	22°	0°	22°	0°	22°	0°	22°	0°		
36,0	23,0	-	-	-	-	-	-	-	-	-	-	-	-	-	-	-	36,0
38,0	21,5	-	-	-	-	-	-	-	-	-	-	-	-	-	-	-	38,0
40,0	20,0	19,6	-	-	-	-	-	-	-	-	-	-	-	-	-	-	40,0
42,0	18,8	18,4	-	-	-	-	-	-	-	-	-	-	-	-	-	-	42,0
44,0	-	17,3	16,9	-	-	-	-	-	-	-	-	-	-	-	-	-	44,0
46,0	-	16,4	16,0	-	-	-	-	-	-	-	-	-	-	-	-	-	46,0
48,0	-	15,4	15,1	14,8	-	-	-	-	-	-	-	-	-	-	-	-	48,0
50,0	-	-	14,3	14,0	-	-	-	-	-	-	-	-	-	-	-	-	50,0
52,0	-	-	13,6	13,2	13,1	-	-	-	-	-	-	-	-	-	-	-	52,0
54,0	-	-	12,9	12,6	12,4	-	-	-	-	-	-	-	-	-	-	-	54,0
56,0	-	-	-	11,9	11,8	11,1	-	-	-	-	-	-	-	-	-	-	56,0
58,0	-	-	-	11,3	11,2	10,5	10,5	-	-	-	-	-	-	-	-	-	58,0
60,0	-	-	-	10,8	10,6	10,0	10,0	9,6	-	-	-	-	-	-	-	-	60,0
62,0	-	-	-	-	10,1	9,5	9,5	9,1	9,1	-	-	-	-	-	-	-	62,0
64,0	-	-	-	-	9,6	9,0	9,0	8,6	8,7	8,4	-	-	-	-	-	-	64,0
66,0	-	-	-	-	9,1	8,5	8,5	8,2	8,2	7,9	-	-	-	-	-	-	66,0
68,0	-	-	-	-	-	8,1	8,1	7,8	7,8	7,5	-	-	-	-	-	-	68,0
70,0	-	-	-	-	-	7,7	-	7,4	7,4	7,1	-	-	-	-	-	-	70,0
72,0	-	-	-	-	-	7,3	-	7,0	7,0	6,8	-	-	-	-	-	-	72,0
74,0	-	-	-	-	-	-	-	6,6	6,7	6,4	-	-	-	-	-	-	74,0
76,0	-	-	-	-	-	-	-	6,3	-	6,1	-	-	-	-	-	-	76,0
78,0	-	-	-	-	-	-	-	-	-	5,8	-	-	-	-	-	-	78,0
80,0	-	-	-	-	-	-	-	-	-	5,5	-	-	-	-	-	-	80,0
82,0	-	-	-	-	-	-	-	-	-	5,2	-	-	-	-	-	-	82,0



60°
39,89 m



0 - 22°
25 - 67 m



8,5 m



360°



135 t



EN 13000

m	25,00		31,00		37,00		43,00		49,00		55,00		61,00		67,00		m
	0°	0°	0°	0°	0°	0°	0°	22°	0°	22°	0°	22°	0°	22°	0°		
38,0	19,9	-	-	-	-	-	-	-	-	-	-	-	-	-	-	-	38,0
40,0	18,7	-	-	-	-	-	-	-	-	-	-	-	-	-	-	-	40,0
42,0	17,5	17,2	-	-	-	-	-	-	-	-	-	-	-	-	-	-	42,0
44,0	16,5	16,2	-	-	-	-	-	-	-	-	-	-	-	-	-	-	44,0
46,0	-	15,3	-	-	-	-	-	-	-	-	-	-	-	-	-	-	46,0
48,0	-	14,5	14,0	-	-	-	-	-	-	-	-	-	-	-	-	-	48,0
50,0	-	13,7	13,3	-	-	-	-	-	-	-	-	-	-	-	-	-	50,0
52,0	-	-	12,6	12,0	-	-	-	-	-	-	-	-	-	-	-	-	52,0
54,0	-	-	11,9	11,4	-	-	-	-	-	-	-	-	-	-	-	-	54,0
56,0	-	-	11,3	10,8	10,4	-	-	-	-	-	-	-	-	-	-	-	56,0
58,0	-	-	-	10,2	9,8	-	-	-	-	-	-	-	-	-	-	-	58,0
60,0	-	-	-	9,7	9,3	8,6	8,6	-	-	-	-	-	-	-	-	-	60,0
62,0	-	-	-	9,2	8,8	8,2	8,2	-	-	-	-	-	-	-	-	-	62,0
64,0	-	-	-	-	8,4	7,7	7,7	7,4	7,4	-	-	-	-	-	-	-	64,0
66,0	-	-	-	-	7,9	7,3	7,3	7,0	7,0	-	-	-	-	-	-	-	66,0
68,0	-	-	-	-	7,5	6,9	6,9	6,6	6,6	6,5	-	-	-	-	-	-	68,0
70,0	-	-	-	-	-	6,5	6,5	6,2	6,2	6,2	-	-	-	-	-	-	70,0
72,0	-	-	-	-	-	6,2	6,2	5,9	5,9	5,8	-	-	-	-	-	-	72,0
74,0	-	-	-	-	-	5,8	-	5,5	5,5	5,5	-	-	-	-	-	-	74,0
76,0	-	-	-	-	-	-	-	5,2	5,2	5,2	-	-	-	-	-	-	76,0
78,0	-	-	-	-	-	-	-	4,9	4,9	4,9	-	-	-	-	-	-	78,0
80,0	-	-	-	-	-	-	-	4,6	-	4,6	-	-	-	-	-	-	80,0
82,0	-	-	-	-	-	-	-	-	-	4,3	-	-	-	-	-	-	82,0
84,0	-	-	-	-	-	-	-	-	-	4,1	-	-	-	-	-	-	84,0

Load charts • Traglasten • Capacités de levage Capacidades • Capacità • Таблицы грузоподъемности

MEGAWINGLIFT

Luffing jib • Wippspitzenausleger • Volée variable • Plumín de angulación variable • Jib a volata variable • Маневровый гусек



60°
44,79 m



0 - 22°
25 - 67 m



8,5 m



360°



135 t



EN 13000

m	25,00		31,00		37,00		43,00		49,00		55,00		61,00		67,00		m
	0°	0°	0°	0°	0°	0°	0°	22°	0°	22°	0°	22°	0°	22°	0°		
42,0	16,4	-	-	-	-	-	-	-	-	-	-	-	-	-	-	-	42,0
44,0	15,5	-	-	-	-	-	-	-	-	-	-	-	-	-	-	-	44,0
46,0	14,6	14,0	-	-	-	-	-	-	-	-	-	-	-	-	-	-	46,0
48,0	-	13,3	-	-	-	-	-	-	-	-	-	-	-	-	-	-	48,0
50,0	-	12,5	12,0	-	-	-	-	-	-	-	-	-	-	-	-	-	50,0
52,0	-	11,8	11,4	-	-	-	-	-	-	-	-	-	-	-	-	-	52,0
54,0	-	-	10,8	10,2	-	-	-	-	-	-	-	-	-	-	-	-	54,0
56,0	-	-	10,2	9,6	-	-	-	-	-	-	-	-	-	-	-	-	56,0
58,0	-	-	9,7	9,1	8,7	-	-	-	-	-	-	-	-	-	-	-	58,0
60,0	-	-	-	8,6	8,2	-	-	-	-	-	-	-	-	-	-	-	60,0
62,0	-	-	-	8,2	7,7	7,1	-	-	-	-	-	-	-	-	-	-	62,0
64,0	-	-	-	7,7	7,3	6,7	6,7	-	-	-	-	-	-	-	-	-	64,0
66,0	-	-	-	-	6,9	6,3	6,3	6,1	-	-	-	-	-	-	-	-	66,0
68,0	-	-	-	-	6,5	5,9	5,9	5,8	5,8	-	-	-	-	-	-	-	68,0
70,0	-	-	-	-	6,2	5,6	5,6	5,4	5,4	5,2	-	-	-	-	-	-	70,0
72,0	-	-	-	-	-	5,2	5,2	5,1	5,1	4,8	-	-	-	-	-	-	72,0
74,0	-	-	-	-	-	4,9	4,9	4,8	4,8	4,5	4,5	-	-	-	-	-	74,0
76,0	-	-	-	-	-	4,6	-	4,5	4,5	4,3	-	-	-	-	-	-	76,0
78,0	-	-	-	-	-	-	-	4,2	4,2	4,0	-	-	-	-	-	-	78,0
80,0	-	-	-	-	-	-	-	3,9	3,9	3,7	-	-	-	-	-	-	80,0
82,0	-	-	-	-	-	-	-	-	3,7	-	-	-	-	-	-	-	82,0
84,0	-	-	-	-	-	-	-	-	-	3,2	-	-	-	-	-	-	84,0
86,0	-	-	-	-	-	-	-	-	-	3,0	-	-	-	-	-	-	86,0
88,0	-	-	-	-	-	-	-	-	-	2,7	-	-	-	-	-	-	88,0



60°
49,69 m



0 - 22°
25 - 67 m



8,5 m



360°



135 t



EN 13000

m	25,00		31,00		37,00		43,00		49,00		55,00		61,00		67,00		m
	0°	0°	0°	0°	0°	0°	0°	22°	0°	22°	0°	22°	0°	22°	0°		
44,0	14,3	-	-	-	-	-	-	-	-	-	-	-	-	-	-	-	44,0
46,0	13,5	-	-	-	-	-	-	-	-	-	-	-	-	-	-	-	46,0
48,0	12,7	-	-	-	-	-	-	-	-	-	-	-	-	-	-	-	48,0
50,0	11,9	11,5	-	-	-	-	-	-	-	-	-	-	-	-	-	-	50,0
52,0	-	10,9	-	-	-	-	-	-	-	-	-	-	-	-	-	-	52,0
54,0	-	10,2	9,7	-	-	-	-	-	-	-	-	-	-	-	-	-	54,0
56,0	-	9,6	9,2	-	-	-	-	-	-	-	-	-	-	-	-	-	56,0
58,0	-	-	8,7	8,1	-	-	-	-	-	-	-	-	-	-	-	-	58,0
60,0	-	-	8,2	7,7	-	-	-	-	-	-	-	-	-	-	-	-	60,0
62,0	-	-	7,7	7,2	6,8	-	-	-	-	-	-	-	-	-	-	-	62,0
64,0	-	-	-	6,8	6,4	-	-	-	-	-	-	-	-	-	-	-	64,0
66,0	-	-	-	6,4	6,0	5,6	5,6	-	-	-	-	-	-	-	-	-	66,0
68,0	-	-	-	6,0	5,7	5,2	5,2	-	-	-	-	-	-	-	-	-	68,0
70,0	-	-	-	-	5,3	4,9	4,9	4,5	-	-	-	-	-	-	-	-	70,0
72,0	-	-	-	-	5,0	4,6	4,6	4,2	4,2	3,9	-	-	-	-	-	-	72,0
74,0	-	-	-	-	4,7	4,3	4,3	4,0	4,0	3,7	3,7	-	-	-	-	-	74,0
76,0	-	-	-	-	-	4,0	4,0	3,7	3,7	3,4	3,4	-	-	-	-	-	76,0
78,0	-	-	-	-	-	3,7	3,7	3,4	3,4	3,1	-	-	-	-	-	-	78,0
80,0	-	-	-	-	-	3,4	-	3,2	3,2	2,9	-	-	-	-	-	-	80,0
82,0	-	-	-	-	-	-	-	2,9	2,9	2,7	-	-	-	-	-	-	82,0
84,0	-	-	-	-	-	-	-	2,7	-	2,4	-	-	-	-	-	-	84,0
86,0	-	-	-	-	-	-	-	2,4	-	2,2	-	-	-	-	-	-	86,0
88,0	-	-	-	-	-	-	-	-	-	2,0	-	-	-	-	-	-	88,0
90,0	-	-	-	-	-	-	-	-	-	1,8	-	-	-	-	-	-	90,0

Load charts • Traglasten • Capacités de levage Capacidades • Capacità • Таблицы грузоподъемности

MEGAWINGLIFT

Luffing jib • Wippspitzenausleger • Volée variable • Plumín de angulación variable • Jib a volata variable • Маневровый гусек



60°
54,59 m



0 - 22°
25 - 67 m



8,5 m



360°



135 t



EN 13000

m	25,00	31,00	37,00	43,00	49,00	55,00		61,00		67,00	m
	0°	0°	0°	0°	0°	0°	22°	0°	22°	0°	
48,0	11,8	-	-	-	-	-	-	-	-	-	48,0
50,0	11,1	-	-	-	-	-	-	-	-	-	50,0
52,0	10,4	-	-	-	-	-	-	-	-	-	52,0
54,0	-	9,3	-	-	-	-	-	-	-	-	54,0
56,0	-	8,8	8,3	-	-	-	-	-	-	-	56,0
58,0	-	8,3	7,8	-	-	-	-	-	-	-	58,0
60,0	-	-	7,4	-	-	-	-	-	-	-	60,0
62,0	-	-	7,0	6,4	-	-	-	-	-	-	62,0
64,0	-	-	6,5	6,0	-	-	-	-	-	-	64,0
66,0	-	-	-	5,6	5,4	-	-	-	-	-	66,0
68,0	-	-	-	5,3	5,1	4,4	-	-	-	-	68,0
70,0	-	-	-	4,9	4,7	4,1	4,1	-	-	-	70,0
72,0	-	-	-	-	4,4	3,8	3,8	3,4	-	-	72,0
74,0	-	-	-	-	4,1	3,5	3,5	3,1	3,2	-	74,0
76,0	-	-	-	-	3,8	3,3	3,3	2,9	2,9	2,6	76,0
78,0	-	-	-	-	-	3,0	3,0	2,7	2,7	2,4	78,0
80,0	-	-	-	-	-	2,7	2,7	2,4	2,4	2,1	80,0
82,0	-	-	-	-	-	2,5	-	2,2	2,2	1,9	82,0
84,0	-	-	-	-	-	-	-	2,0	2,0	1,7	84,0
86,0	-	-	-	-	-	-	-	1,8	1,8	-	86,0

Load charts • Traglasten • Capacités de levage Capacidades • Capacità • Таблицы грузоподъемности

MEGAWINGLIFT

Heavy Duty Jib • Schwerlastspitze • Flèche haute résistance • Pluma de alta resistencia • Falcone con braccetto heavy duty • Стрела для тяжелых условий эксплуатации

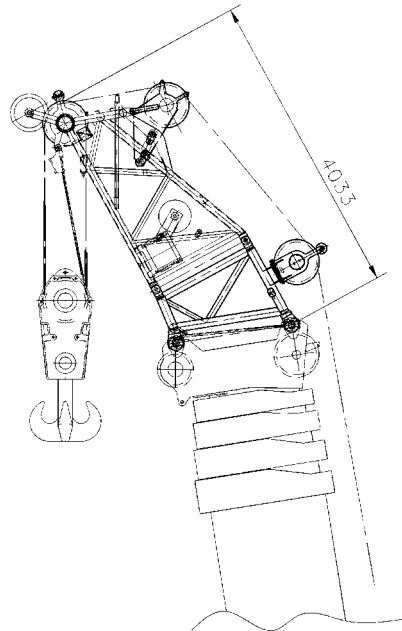

20° - 4 m



8,5 m



360°



135 t



EN 13000

m	34,99	39,89	44,79	49,69	54,59	60,00	m
9,0	75,0	75,0	-	-	-	-	9,0
10,0	75,0	75,0	75,0	-	-	-	10,0
11,0	75,0	75,0	75,0	75,0	-	-	11,0
12,0	75,0	75,0	73,5	72,0	68,5	-	12,0
13,0	75,0	71,5	69,5	68,0	66,5	59,5	13,0
14,0	71,5	68,0	65,5	64,0	63,0	57,5	14,0
15,0	68,0	64,5	62,0	60,5	59,5	55,5	15,0
16,0	64,0	61,5	59,0	57,5	56,5	53,5	16,0
18,0	56,0	55,5	54,0	52,5	51,0	49,5	18,0
20,0	49,5	49,0	49,0	48,0	47,0	45,5	20,0
22,0	43,5	43,0	43,5	44,0	43,5	42,0	22,0
24,0	38,5	38,0	38,0	39,0	39,5	39,0	24,0
26,0	34,5	34,0	34,0	34,5	35,0	35,5	26,0
28,0	30,5	30,0	30,5	31,0	31,5	31,5	28,0
30,0	27,5	27,0	27,0	27,5	28,5	28,5	30,0
32,0	23,5	24,5	24,5	25,0	25,5	26,0	32,0
34,0	20,0	22,0	22,0	22,5	23,0	23,5	34,0
36,0	-	18,7	19,9	20,5	21,0	21,5	36,0
38,0	-	16,7	18,0	18,5	19,2	19,4	38,0
40,0	-	-	15,5	16,8	17,5	17,7	40,0
42,0	-	-	12,2	15,3	16,0	16,1	42,0
44,0	-	-	-	13,2	14,6	14,7	44,0
46,0	-	-	-	10,6	13,3	13,5	46,0
48,0	-	-	-	9,1	11,6	12,3	48,0
50,0	-	-	-	-	9,4	11,3	50,0
52,0	-	-	-	-	8,2	9,9	52,0
54,0	-	-	-	-	-	8,1	54,0
56,0	-	-	-	-	-	6,2	56,0
58,0	-	-	-	-	-	5,1	58,0

Load charts • Traglasten • Capacités de levage Capacidades • Capacità • Таблицы грузоподъемности

MEGAWINGLIFT

Heavy Duty Jib • Schwerlastspitze • Flèche haute résistance • Pluma de alta resistencia • Falcone con braccetto heavy duty • Стрела для тяжелых условий эксплуатации

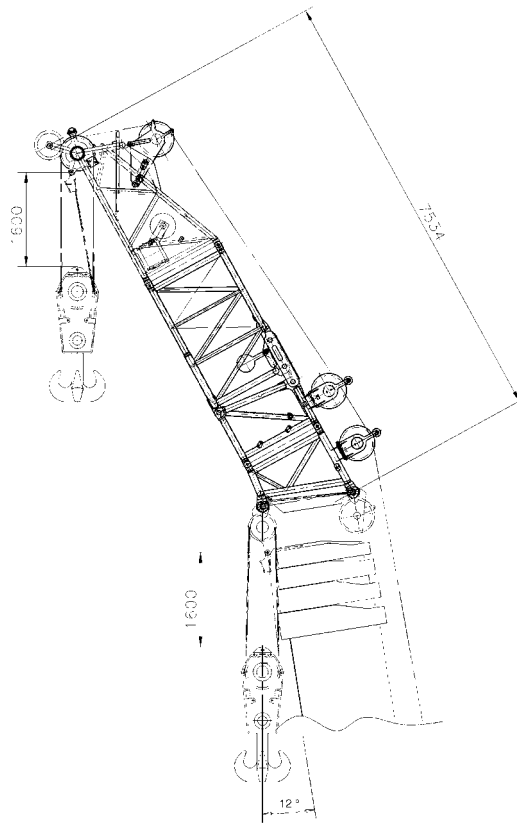

20° - 7,5 m



8,5 m



360°



135 t



EN 13000

m	34,99	39,89	44,79	49,69	54,59	60,00	m
10,0	44,5	-	-	-	-	-	10,0
11,0	43,5	44,5	-	-	-	-	11,0
12,0	42,5	43,5	44,0	-	-	-	12,0
13,0	42,0	42,5	43,0	43,5	-	-	13,0
14,0	41,0	42,0	42,5	43,0	-	-	14,0
15,0	40,5	41,0	42,0	42,5	42,5	-	15,0
16,0	39,5	40,5	41,0	41,5	42,0	41,5	16,0
18,0	38,5	39,5	40,0	40,5	41,0	40,5	18,0
20,0	37,0	38,0	39,0	39,5	39,5	39,0	20,0
22,0	35,5	37,0	38,0	38,5	38,5	37,5	22,0
24,0	35,0	36,0	37,0	37,5	37,5	35,5	24,0
26,0	34,5	34,5	34,5	35,0	35,5	33,5	26,0
28,0	31,5	31,0	31,0	31,5	32,0	31,5	28,0
30,0	28,0	27,5	27,5	28,0	28,5	28,5	30,0
32,0	25,5	25,0	25,0	25,5	26,0	26,0	32,0
34,0	23,0	22,5	22,5	23,0	23,5	23,5	34,0
36,0	18,7	20,0	20,5	20,5	21,5	21,5	36,0
38,0	15,2	18,2	18,4	18,8	19,3	19,4	38,0
40,0	-	14,9	16,6	17,0	17,6	17,7	40,0
42,0	-	12,8	14,9	15,5	16,0	16,1	42,0
44,0	-	-	12,3	14,0	14,6	14,7	44,0
46,0	-	-	10,8	12,6	13,3	13,4	46,0
48,0	-	-	-	10,4	12,1	12,2	48,0
50,0	-	-	-	7,9	10,8	11,1	50,0
52,0	-	-	-	-	9,0	10,1	52,0
54,0	-	-	-	-	7,0	9,0	54,0
56,0	-	-	-	-	5,9	7,4	56,0
58,0	-	-	-	-	-	5,8	58,0
60,0	-	-	-	-	-	4,9	60,0

Load charts • Traglasten • Capacités de levage Capacidades • Capacità • Таблицы грузоподъемности

MEGAWINGLIFT

Heavy Duty Jib • Schwerlastspitze • Flèche haute résistance • Pluma de alta resistencia • Falcone con braccetto heavy duty • Стрела для тяжелых условий эксплуатации

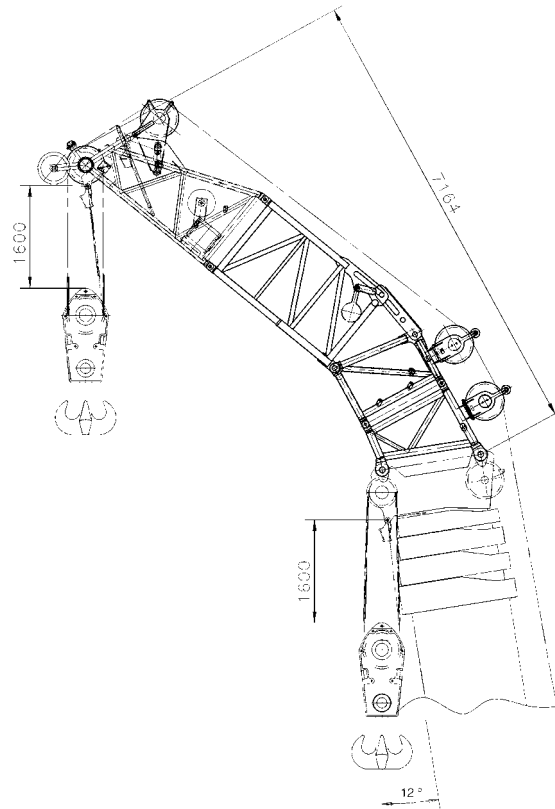

42° - 7,5 m



8,5 m



360°



135 t

EN 13000



m	34,99	39,89	44,79	49,69	54,59	60,00	m
12,0	35,0	35,5	-	-	-	-	12,0
13,0	35,0	35,0	35,5	-	-	-	13,0
14,0	34,5	35,0	35,0	-	-	-	14,0
15,0	34,0	34,5	35,0	35,0	-	-	15,0
16,0	34,0	34,0	34,5	34,5	34,5	-	16,0
18,0	33,5	33,5	34,0	34,0	34,5	34,5	18,0
20,0	33,0	33,0	33,5	33,5	34,0	34,0	20,0
22,0	32,5	33,0	33,0	33,5	33,5	33,5	22,0
24,0	32,5	32,5	33,0	33,0	33,0	33,0	24,0
26,0	32,5	32,5	32,5	33,0	33,0	31,5	26,0
28,0	31,5	31,5	31,5	32,0	32,0	30,5	28,0
30,0	28,5	28,0	28,5	28,5	29,5	29,0	30,0
32,0	-	25,0	25,5	26,0	26,5	26,5	32,0
34,0	-	22,5	23,0	23,5	24,0	24,0	34,0
36,0	-	-	20,5	21,0	21,5	22,0	36,0
38,0	-	-	18,6	19,1	19,7	19,8	38,0
40,0	-	-	-	17,3	17,9	18,0	40,0
42,0	-	-	-	15,7	16,3	16,4	42,0
44,0	-	-	-	-	14,9	15,0	44,0
46,0	-	-	-	-	-	13,6	46,0
48,0	-	-	-	-	-	12,4	48,0
50,0	-	-	-	-	-	11,3	50,0

Load charts • Traglasten • Capacités de levage Capacidades • Capacità • Таблицы грузоподъемности

Overview • Übersicht • Tableau synoptique • Resumen de las tablas • Tabella riassuntiva • Общие сведения



15,39 – 60,0 m



360°

m	t	8,70 x 8,50 m								8,70 x 7,4 m							
		135,0	115,0	95,0	75,0	55,0	35,0	15,0	0,0	135,0	115,0	95,0	75,0	55,0	35,0	15,0	0,0
15,39	
20,29	
25,19	
26,60	
30,09	
34,99	
37,75	
39,89	
42,64	
44,79	
48,86	
49,69	
54,59	
58,65	
60,00	

m	t	8,70 x 6,30 m						8,70 x 5,0 m			
		95,0	75,0	55,0	35,0	15,0	0,0	55,0	35,0	15,0	0,0
15,39	
20,29	
25,19	
26,60	
30,09	
34,99	
37,75	
39,89	
42,64	
44,79	
48,86	
49,69	
54,59	
58,65	
60,00	



34,99 – 60,0 m + MegaWingLift



360°

m	t	8,70 x 8,50 m						8,70 x 7,40 m					8,70 x 6,30 m	
		135,0	115,0	95,0	75,0	55,0	35,0	135,0	115,0	95,0	75,0	55,0	95,0	75,0
34,99	
39,89	
42,64	
44,79	
49,69	
54,59	
60,00	

Load charts • Traglasten • Capacités de levage Capacidades • Capacità • Таблицы грузоподъемности





Overview • Übersicht • Tableau synoptique • Resumen de las tablas • Tabella riassuntiva • Общие сведения











3° (25°)







360°

 m		8,70 x 8,50																											
 t		135 / 115 / 95 / 75										55																	
 m	 m	12	16	18	22	24	28	30	34	36	40	42	46	52	58	64	12	16	18	22	24	28	30	34	36	40	42	46	52
15,39	
20,29	
25,19	
30,09	
34,99	
39,89	
44,79	
49,69	
54,59	

 m		8,70 x 8,50						8,70 x 7,40																				
 t		35						135 / 115 / 95 / 75																				
 m	 m	12	16	18	22	24	28	30	12	16	18	22	24	28	30	34	36	40	42	46	52	58	64					
15,39	
20,29	
25,19	
30,09	
34,99	
39,89	
44,79	
49,69	
54,59	

 m		8,70 x 7,40										8,70 x 6,30																		
 t		55					35					95																		
 m	 m	12	16	18	22	24	28	30	34	36	40	42	12	16	18	12	16	18	22	24	28	30	34	36	40	42	46	52	58	64
15,39	
20,29	
25,19	
30,09	
34,99	
39,89	
44,79	
49,69	
54,59	

 m		8,70 x 6,30																											
 t		75							55																				
 m	 m	12	16	18	22	24	28	30	34	36	40	42	46	12	16	18	22	24	28	30									
15,39	
20,29	
25,19	
30,09	
34,99	
39,89	
44,79	
49,69	
54,59	

Specifications

Superstructure



Boom

15,4 m to 60,0 m five section TWIN-LOCK™ boom.
Maximum tip height 63,0 m.



Boom elevation

1 cylinder with safety valve, boom angle from -1,5° to +82°.



Load moment and lifting limit switch

Load moment and independent anti-two block system with audio visual warning and control lever lock-out. These systems provide graphic display of boom angle, length, radius, tip height, relative load moment, maximum permissible load, load indication and warning of impending two-block condition with lock-out hoist function.



Cab

Aluminium, full vision, tiltable (approx. 20°), safety glass, adjustable operator's seat with suspension, engine-dependent hot water heater and air condition. Armrest-integrated crane controls. Ergonomically arranged instrumentation and crane operating controls.



Slewing

3 slewing gears with axial piston motors, planetary gear, automatic brake.



Counterweight

135 tonnes, consisting of various sections. Hydraulic removal system.



Hydraulic system

5 separate circuits, 3 axial piston variable displacement pumps with electronic power limit control and 2 gear pump for slewing.
Thermostatically controlled oil cooler. Tank capacity: 1300 l.



Control system

Full electronic control of all crane movements using electrical control levers with automatic reset to zero. Integrated with the RCL (Rated Capacity Limiter) and engine management system by CAN-BUS. ECOS system with graphic display. CRANE STAR Telematic system.



Hoist

Axial piston motor with planetary gear and brake. Drum rotation indicator. Hoist camera and light.

* Optional equipment

- Self-rigging MegaWingLift.
- Heavy duty jib 3,5 m and 7,5 m.
- Lattice extension, 12-64 m, in sections of 6 and 12 m.
- Luffing jib, 25-79 m, in sections of 6 and 12 m.
- Auxiliary hoist, self rigging with counterweight.
- Boom head camera.
- Boom removal kit.

Carrier



Chassis

Special 6-axle chassis, all-welded torsion-resistant box type construction in high strength steel.



Outriggers

4 double hydraulically telescoping beams with vertical cylinders and outrigger pads. Independent horizontal and vertical movement control on each side of the carrier and from the operators cab. Electronic level indicator with automatic levelling system. Working light for each outrigger beam. Outrigger pad load indicator with read out on superstructure and carrier.



Engine

Mercedes-Benz OM502LA, diesel, 8 cylinders, water cooled, turbocharged, 405 kW (551 HP) at 1800 rpm (80/1269 EWG - fan loose). Max. torque: 2600 Nm at 1300 rpm. Fuel tank capacity: 300 l + 350 l.
Engine emission: EUROMOT / EPA / CARB Tier 4i (non road).



Transmission

ZF AS Tronic 12, electronic automatic shifting.



Drive/Steer

12 x 8 x 12.



Axle lines

6 axle lines. Axle 1 & 2 with conventional drive, axle 4 & 5 with MegaDrive™.



Suspension

MEGATRAK®. All wheels with independent hydropneumatic suspension and hydraulic lockout. Longitudinal and transverse level control with automatic on-highway levelling system. Range +170 mm/-130 mm. Active suspension control on outrigger control units.



Tyres

12 tyres, 385/95 R25 (14.00 R25).



Steering

Dual circuit, hydraulic power assisted steering with emergency steering pump. Axle lines 1, 2, 5 and 6 steer on highway (steer by wire). Separate electronic hydraulic (steer by wire) steering of the 3rd to 6th axle line for all wheel steering and crabbing.



Brakes

Service brake: pneumatic dual circuit, acting on all wheels, air dryer. Permanent brake: exhaust brake and constant throttle brake.
Parking brake: pneumatically operated spring-loaded brake acting on axle lines 2, 4, 5 and 6.



Cab

Composite designed aluminium and fibre reinforced plastic, 2-man-design, safety glass, driver seat with pneumatic suspension, engine-dependent hot water heater. Complete instrumentation and driving controls. Reversing camera system. Air condition. 12 V plug. Two strobe lights. Fire extinguisher.



Electrical system

Three-phase alternator 28 V/100A, 2 batteries 12 V/170 Ah. Lighting system and signals 24 V.

* Optional equipment

- 12 tyres, 445/95 R25 (16.00 R25).
- 12 tyres, 525/80 R25 (20.5 R25) - Vehicle width 3,10 m.
- Hydraulic retarder integrated in gear box
- Aluminium rims.
- Folding bunk bed in carrier cab.
- Engine-independent hot water heater, with engine pre-heater.
- Engine shutdown valves (both engines).
- Tier 3 engine: Mercedes-Benz OM 502 LA, 450 kW (612 PS) at 1800 rpm. Max torque: 2700 Nm at 1300 rpm.

*Further optional equipment upon request.

Kranoberwagen



Teleskopausleger

Von 15,4 m bis 60,0 m ausfahrbarer, fünfteiliger TWIN-LOCK™ Ausleger. Maximale Rollenhöhe 63,0 m.



Wippwerk

1 Zylinder mit Sicherheits-Rückschlagventil. Auslegerstellwinkel -1,5° bis +82°.



Elektronischer Lastmomentbegrenzer und Hubendschalter

Elektronischer Lastmomentbegrenzer mit hör- und sichtbarer Vorwarnung sowie automatischer Abschaltung, grafische Anzeige für tatsächliche und zulässige Belastung, Ausladung und diverse Zustände. Unabhängiges Hubendschalter-System mit Abschaltfunktion.



Krankabine

Vollsicht-Aluminium-Kabine, ca. 20° kippbar, Sicherheitsglas, verstellbarer Fahrersitz mit Dämpfung. In Armlehnen integrierte Kransteuereinrichtung. Ergonomisch angeordnete Steuer- und Kontrolleinrichtungen. Motorunabhängige Luftheizung, Klimaanlage.



Drehwerk

3 Drehwerke mit Axialkolbenmotoren, Planetengetriebe, automatische Bremse.



Gegengewicht

135 t bestehend aus mehreren Teilen. Hydraulisches Rüstsystem.



Hydrauliksystem

5 separate Kreisläufe, 3 Axialkolben-Verstellpumpen mit elektronischer Grenzlastregelung und 2 Zahnradpumpen für das Drehwerk. Thermostatisch gesteuerter Ölkühler. Tankvolumen: 1300 l Hydrauliköl.



Steuerung

Voll elektronische Steuerung aller Bewegungen mit elektronisch Kreuzsteuerhebeln mit automatischer Nullstellung, verbunden mit der LMB und dem Motormanagement System über einen CAN-BUS. ECOS System mit grafischer Anzeige. Crane Star Telematiksystem.



Hubwerk

Axialkolbenmotor mit Planetengetriebe und Bremse. Hubwerksdrehmelder. Hubwerkskamera und Beleuchtung.

* Zusatzausrüstung

- Selbstrüstender MegaWingLift.
- Schwerlastspitze 3,5 m und 7,5 m.
- Auslegerverlängerung, Gitterkonstruktion 12-64 m, in 6 m Abstufungen.
- Wippspitzenausleger, Gitterkonstruktion 25-79 m, in 6 und 12 m Abstufungen.
- Hilfshubwerk selbstrüstend über das Gegengewicht.
- Auslegerkopfkamera.
- Auslegerdemontage-Set.

Kranunterwagen



Rahmen

6-Achs-Spezialfahrzeug, geschweißte, torsionssteife Kastenkonstruktion aus hochfestem Feinkornstahl.



Abstützung

4 hydraulisch doppelt teleskopierbare Schiebeträger mit Abstützzyllindern und Abstützplatten, beidseitig vom Unterwagen und aus der Krankabine einzeln horizontal und vertikal steuerbar. Elektronische Niveauanzeige mit automatischer Nivellierung. In die Unterwagenbeleuchtung integrierte Arbeitsscheinwerfer für die Abstützträger. Stützdruckanzeige am Unterwagen und Oberwagen.



Motor

Mercedes-Benz OM502LA, 8 Zylinder Diesel, wassergekühlt mit Abgasturbolader, 405 kW (551 PS) bei 1800 min⁻¹ (80/1269/EWG Ventilator lose), max. Drehmoment 2600 Nm bei 1300 min⁻¹. Kraftstoffbehälter: 300 l + 350 l. Motoremission: EUROMOT / EPA / CARB Tier 4i (non road).



Getriebe

ZF AS Tronic 12, automatisiertes Schaltgetriebe.



Antrieb/Lenkung

12 x 8 x 12.



Achslinien

6 Achslinien, Achslinien 1 und 2 mit konventionellem Antrieb, Achslinien 4 und 5 mit MegaDrive™.



Federung

MEGATRAK®. Alle Räder in Einzelradaufhängung, hydropneumatische Federung und hydraulische Blockierung. Neigungsverstellung in alle Richtungen und automatische Straßenfahrtniveaueinstellung. Federweg +170mm/-130mm. Achsanhebung an Abstützungsbedieneinheit.



Bereifung

12 Reifen, Größe 385/95 R25 (14.00 R25).



Lenkung

Zweikreis-Hydraulenkung mit Notlenkpumpe. Während der Straßenfahrt werden die 1., 2., 5. und 6. Achse (steer by wire) gelenkt. Separate elektronisch-hydraulische Lenkung der 3. bis 6. Achslinie für Allradlenkung und Krabbengang.



Bremsen

Betriebsbremse: pneumatische Zweikreisbremse, auf alle Räder wirkend, Lufttrockner. Dauerbremse: Motorklappenbremse mit Konstantdrossel. Feststellbremse: Druckluftbetätigte Federspeicherbremse auf 2., 4., 5. und 6. Achslinie wirkend.



Fahrerhaus

Aluminium- und faserverstärkte Kunststoffkombination, 2-Mann-Fahrerhaus, Sicherheitsglas, luftgedämpfter Fahrersitz, motorabhängige Warmwasserheizung. Kontroll- und Bedienungseinrichtung für Fahrbetrieb. Rückfahrkamerasystem. Klimaanlage. 12 V-Anschluß. Zwei Rundumkennleuchten. Feuerlöscher.



Elektrische Anlage

Drehstromlichtmaschine 28 V/100 A, 2 Batterien 12 V/170 Ah, Beleuchtung und Signaleinrichtung 24 V.

* Zusatzausrüstung

- 12 Reifen, Größe 445/95 R25 (16.00 R25).
- 12 Reifen, Größe 525/80 R25 (20.5 R25) - Fahrzeugbreite 3,10 m.
- Hydraulischer sekundär Retarder.
- Aluminiumfelgen.
- Klappliege im Fahrerhaus.
- Motorunabhängige Warmwasser-Standardheizung mit Motorvorwärmung.
- Luftreinlassabsperrentil (AMOT).
- Tier 3 Motor: Mercedes-Benz OM 502 LA, 450 kW (612 PS) bei 1800 min⁻¹. Max. Drehmoment: 2700 Nm bei 1300 min⁻¹.

*Weitere Zusatzausrüstungen auf Anfrage.

Caractéristiques techniques

Superstructure



Flèche

Flèche cinq éléments de 15,4 m à 60,0 m, à télescopage TWIN-LOCK™. Hauteur maximum de tête de flèche 63,0 m.



Relevage

1 vérin avec clapet anti-retour, angle de relevage de - 1,5° à +82°.



Contrôleur d'état de charge et interrupteur de fin de course haute

Équipements électroniques de contrôle de charge et de fin de course haute crochet indépendants avec dispositifs de signalisation sonore et visuelle et de coupure des mouvements. Affichage graphique d'angle et de longueur de flèche, de portée, de hauteur de tête de flèche, de moment relatif, de charge maximum autorisée, d'état de charge et d'approche de fin de course haute crochet avec coupure du mouvement de montée de treuil.



Cabine

Cabine **Aluminium**, inclinable (angle d'inclinaison environ 20°), largement vitrée, avec vitrage de sécurité, hydraulique suspendu et chauffage à eau chaude alimenté par le moteur, air conditionné. Disposition ergonomique des commandes de grue intégrées dans les accoudoirs et de l'instrumentation.



Orientation

Dispositif d'orientation triple avec moteurs hydrauliques à pistons axiaux, frein à serrage automatique.



Contrepoids

Contrepoids modulaire de 135 t. Système de dépose hydraulique.



Système hydraulique

5 circuits indépendants, 3 pompes à pistons axiaux avec système de contrôle de charge et 2 pompes à engrenage pour l'orientation. Refroidisseur d'huile à commande thermostatique. Capacité du réservoir : 1300 l.



Commande

Commandes de grue électroniques par manipulateurs électriques avec retour au neutre automatique. Ces commandes sont reliées au contrôleur d'état de charge et au dispositif de gestion du moteur thermique par système CAN-BUS. Système ECOS avec affichage graphique. Crane Star, système télématique.



Treuil de levage

Treuil avec tambour rainuré, réducteur à planétaires, frein multidisque, moteur à pistons axiaux et indicateur de rotation. Caméra et éclairage du treuil.

* Equipements optionnels

- Montage automatique MegaWingLift.
- Flèche de haute résistance 3,5 m et 7,5 m.
- Extension treillis de 12-64 m constituée d'éléments de 6 et 12 m.
- Extension treillis à volée variable de 25 à 79 m par éléments de 6 et 12 m.
- Treuil auxiliaire, auto-câblage avec contrepoids.
- Caméra de tête de flèche.
- Equipement de dépose de flèche.

Porteur



Châssis

Porteur spécial, « 6 lignes d'essieux », mécanosoudé, type caisson, en acier à haute limite élastique.



Calage

4 poutres à télescopage hydraulique, avec vérins et patins d'appui. Commande indépendante des mouvements verticaux et horizontaux sur les deux côtés du porteur et depuis la cabine de l'opérateur. Indicateur de mise à niveau électronique avec système de mise à niveau automatique. Projecteur de travail sur les bras de télescopage. Indicateur de charge des patins d'appui avec mesure affichée sur la superstructure et le châssis.



Moteur

Moteur Diesel Mercedes-Benz OM502LA, 8 cylindres suralimenté, refroidi par eau et développant 405 kW (551 CV) à 1800 min⁻¹ (80/1269 EWG - ventilateur débrayable). Couple maxi 2600 Nm à 1300 min⁻¹. Capacité du réservoir : env. 300 l plus 350 l.

Conformité aux normes de pollution EUROMOT / EPA / CARB Tier 4i (tout terrain).



Boîte de vitesses

Boîte automatique à contrôle électronique ZF AS Tronic 12.



Direction/Transmission

12 x 8 x 12.



Lignes d'essieux

6 lignes d'essieu. Essieux 1 et 2 à entraînement conventionnel, essieux 4 & 5 à entraînement MegaDrive™.



Suspension

Suspension hydropneumatique à roues indépendantes MEGATRAK® et dispositif de verrouillage. Commandes de mise à niveau longitudinal et transversal. Dispositif de mise à niveau automatique en position route. Débattement: +170 mm/-130 mm. Contrôle de suspension actif sur les unités de commande de calage.



Pneumatiques

12 pneumatiques 385/95 R25 (14.00 R25).



Direction

Direction assistée à double circuit et pompe de secours. Lignes d'essieux 1, 2, 5 et 6 directionnelles sur route (direction par câble). Direction hydraulique et électronique indépendante (direction par câble) direction indépendante pour les lignes d'essieux 3 à 6 pour réduction du diamètre de braquage et déplacement latéral (marche en crabe).



Freins

Frein de service pneumatique à double circuit agissant sur toutes les roues. Dessiccateur. Ralentisseur par clapet sur échappement et décalage de la distribution. Frein de stationnement à ressorts commandé pneumatiquement agissant sur les lignes d'essieux 2, 4, 5 et 6.



Cabine

Plastique renforcé par fibre de verre et aluminium. Cabine bi-place avec vitrage de sécurité, suspension pneumatique suspendu, chauffage à eau chaude alimenté par le moteur et instrumentation complète pour le contrôle et la conduite de la machine. Caméra de recul. Air conditionné. Batterie 12 V. Deux éclairages troscopiques. Extincteur.



Installation électrique

Alternateur triphasé 28 V/100 A et 2 batteries 12 V/170 Ah, équipement d'éclairage et de signalisation routière : 24 V.

* Equipements optionnels

- 12 pneumatiques 445/95 R25 (16.00 R25).
- 12 pneumatiques 525/80 R25 (20.5 R25) - Largeur du véhicule 3,10 m.
- Ralentisseur hydraulique intégré dans la boîte de vitesses.
- Jantes aluminium.
- Banquette repliable dans la cabine porteur.
- Chauffage auxiliaire à eau chaude indépendant avec dispositif de préchauffage moteur.
- Clapets de coupure d'air pour le moteur.
- Moteur Tier 3 : Mercedes-Benz OM 502 LA, 450 kW (612 PS) à 1800 min⁻¹. Couple maxi : 2700 Nm à 1300 min⁻¹.

* Autres équipements optionnels sur demande.

Superestructura



Pluma

De 15,4 m a 60,0 m cinco secciones telescópicas sistema TWIN-LOCK™. Altura máxima en punta 63,0 m



Elevación de pluma

Un cilindro con válvula de seguridad. Angulo de pluma desde -1,5° hasta +82°.



Sistema indicador del momento de carga e interruptor de final de carrera del gancho

Sistema Indicador del Momento de Carga y de Final de Carrera del Gancho, con alarma audio-visual y bloqueo automático de las palancas. Este sistema incluye pantalla gráfica con indicación de ángulo de pluma, longitud, radio, altura de cabeza de pluma, momento de carga relativo, carga máxima permisible, carga real y alarma de fin de carrera del gancho con bloqueo del movimiento de elevación.



Cabina

De **Aluminio** basculable (aprox. 20°), amplia visibilidad, cristales de seguridad, asiento del operador ajustable y con hidráulica suspensión. Calefacción dependiente del motor por agua caliente. Aire acondicionado. Controles de la grúa integrados en el apoya-brazos. Controles de operación de la grúa e instrumentación ergonómicamente situados.



Giro

Tres reductores de giro con motores de pistón axial, engranaje planetario, freno automático.



Contrapeso

De 135 Tn, compuesto de varios bloques. Sistema hidráulico para desmontaje.



Sistema hidráulico

5 circuitos separados, 2 bombas de desplazamiento de caudal variable con pistones axiales, con control electrónico de limitación de potencia y 2 bombas para la rotación. Refrigerador de aceite controlado por termostato. Capacidad del depósito: 1300 l.



Sistema de control

Control completamente electrónico de todos los movimientos de la grúa, usando mandos de control eléctrico con retorno automático a cero. Integrado con el Limitador de Cargas y el sistema de control del motor mediante "CAN-BUS". Sistema ECOS con indicador gráfico. Crane Star, sistema telemático.



Cabrestante

Motor de pistón axial con engranaje planetario y freno. Indicador de rotación del tambor. Luz y cámara de cabrestante.

* Equipos opcionales

- Sistema MegaWingLift con automontaje.
- Plumín de alta resistencia de 3,5 m y 7,5 m.
- Plumín fijo de celosía, 12-64 m, en secciones de 6 y 12 m.
- Plumín abatible, 25-79 m, en secciones de 6 y 12 m.
- Cabrestante auxiliar, reglaje autónomo con contrapeso.
- Cámara de video en la punta de la pluma.
- Kit de desmontaje de pluma.

Chasis



Bastidor

Chasis especial de seis ejes de construcción soldada tipo cajón, resistente a la torsión, en acero de alta resistencia.



Estabilizadores

Cuatro vigas telescópicas hidráulicas con cilindros verticales y placas de apoyo. Controles independientes para los movimientos horizontales y verticales, con controles en ambos lados del chasis y desde la cabina del operador. Indicador de nivel electrónico con sistema de nivelación automática. Luz de trabajo en cada estabilizador. Indicador de carga de la plataforma del estabilizador con lectura de superestructura y chasis.



Motor

Diesel Mercedes Benz OM502LA, 8 cilindros, refrigerado por agua y turbo-alimentado, 405 Kw (551 PS) a 1800 r.p.m. (80/1269 EWG - ventilador desconectado), par máximo: 2600 Nm, a 1300 r.p.m. Capacidad del Depósito de Combustible: 300 + 350 litros. Emisión de gases: Según normas EUROMOT / EPA / CARB Tier 4i (fuera de carretera).



Transmisión

ZF AS Tronic 12, cambio electrónico automático.



Tracción/Dirección

12 x 8 x 12.



Ejes

6 ejes. Ejes 1 y 2 con tracción convencional, ejes 4 y 5 con MegaDrive™.



Suspensión

MEGATRAK®. Todas las ruedas con suspensión hidroneumática independiente y bloqueo hidráulico. Control de nivel longitudinal y transversal con sistema de nivelación automática en carretera. Desplazamiento +170 mm / -130 mm. Control de la suspensión activo en las unidades de control del estabilizador.



Neumáticos

12 neumáticos, 385/95 R25 (14.00 R25).



Dirección

Dirección servo-asistida con doble circuito con bomba de dirección de emergencia. Los ejes 1, 2, 5 y 6 son directrices para circular por carretera (dirección por cable). Dirección separada hidráulica electrónica separada (dirección por cable) de los ejes 3, 4, 5 y 6 para la dirección en todas las ruedas y conducción tipo cangrejo.



Frenos

Frenos de servicio: Neumático con doble circuito, actuando sobre todas las ruedas, secador de aire. Freno continuo: Freno sobre el escape, con estrangulamiento continuo. Freno de Aparcamiento: Operado neumáticamente y aplicado por muelle sobre los ejes 2, 4, 5 y 6.



Cabina

Plástico reforzado de fibra y aluminio compuesto, para dos personas, cristales de seguridad, asientos del conductor y pasajero con neumática suspensión, calefacción por agua caliente del motor. Controles e instrumentación para conducción del vehículo. Sistema de cámara invertida. Aire acondicionado. Conector de 12 V. Dos luces estroboscópicas. Extintor.



Sistema eléctrico

Trifásico, alternador de 28 V/100A, 2 baterías 12 V/170 Ah. Sistema de alumbrado y señalización a 24 V.

* Equipos opcionales

- 12 neumáticos 445/95 R25 (16.00 R25).
- 12 neumáticos 525/80 R25 (20.5 R25) - Anchura del vehículo: 3,10 m.
- Llantas de aluminio.
- Litera plegable en la cabina del chasis.
- Calefacción independiente del motor por agua caliente, con precalentamiento del motor.
- Válvula de apagado del motor.
- Motor Tier 3 : Mercedes-Benz OM 502 LA, 450 kW (612 PS) a 1800 r.p.m. par máximo : 2700 Nm a 1300 r.p.m.

Caratteristiche

Torretta



Braccio

Da 15,4 a 60,0 metri; cinque sezioni con sfilamento TWIN-LOCK™. Massima altezza in punta 63,0 metri.



Sollevamento Braccio

Un cilindro con valvola di sicurezza, angolo del braccio da -1,5° a +82°.



Limitatore di carico e interruttore di finecorsa alto

Limitatore di carico e finecorsa con allarme visivo e sonoro e blocco delle leve di comando. Il sistema è provvisto di display grafico elettronico riportante l'angolo e la lunghezza del braccio, il raggio di lavoro, l'altezza di lavoro, il momento, il carico massimo ammissibile e il carico sollevato. Allarme per prevenire il fine corsa con blocco delle funzioni dell'argano. Limitatore area di lavoro di serie.



Cabina

Costruita in alluminio con grande visibilità, inclinabile idraulicamente di circa 20° montata a sinistra, cristalli di sicurezza, riscaldamento (dipendente dal motore), aria condizionata, sedile deluxe con sospensione idraulica, poggiatesta e braccioli con joystick di controllo integrati. Strumentazione e pannello di comando disposti in maniera ergonomica.



Rotazione

Rotazione continua a 360°, 3 riduttori planetari con motori a pistone assiali, freno automatico, freno a pedale azionabile come controllo rotazione.



Contrappeso

Da 135 tonnellate composto da varie sezioni. Sistema di allestimento e rimozione idraulico.



Impianto idraulico

5 circuiti indipendenti, 3 pompe a portata variabile a pistoni assiali, con controllo elettronico della potenza e 2 pompe a ingranaggio per la rotazione. Radiatore dell'olio a controllo termostatico. Capacità serbatoio olio idraulico: 1300 l.



Comandi

Controllo completamente elettronico di tutti i movimenti della gru (joystick elettronici) integrato con il sistema LMI (Limitatore di carico) e con il sistema CAN-BUS di controllo del motore. Sistema ECOS con display grafico. Crane Star™ Telematic System.



Argano

Motore a pistoni assiali con riduttore planetario e freno a dischi multipli automatico. Indicatore della rotazione dell'argano. Videocamera sull'argano con luce di lavoro inclusa.

* Accessori opzionali

- Sistema per incrementare le portate MegaWingLift automontante.
- Punta braccio per carichi pesanti da 3,5 m e 7,5 m.
- Jib fisso, 12-64 m, in sezioni di 6 e 12 m.
- Falcone a volata variabile, 25-79 m, in sezioni di 6 e 12 m.
- Argano ausiliario automontante con il contrappeso.
- Telecamera a colori montata sulla testa del braccio.
- Kit di rimozione del braccio.

Carro



Telaio

Telaio speciale a 6 assi completamente saldato in acciaio scotolato ad alta resistenza alla torsione.



Stabilizzatori

4 travi orizzontali telescopiche con cilindri verticali e piatti stabilizzatori. Controllo dei movimenti verticale ed orizzontale indipendente su ogni lato del carro e dalla cabina dell'operatore. Indicatore elettronico del livello, Indicatore del carico su ciascuna trave visibile dai pannelli di comando laterali del carro o dalla sovrastruttura, luci di lavoro su ciascuno stabilizzatore.



Motore

Mercedes Benz OM502LA diesel 8 cilindri raffreddato ad acqua, sovralimentato, potenza di 405 kW (551 HP) a 1800 giri (80/1269 EWG fan loose). Coppia massima 2600 Nm a 1300 giri. Capacità del serbatoio 300 + 350 litri. Emissione gassosa allo scarico nei limiti: EUROMOT / EPA / CARB Tier 4 i (motori non stradali).



Cambio

ZF ASTronic 12, attuatore elettronico automatico.



Trazione/Sterzo

12 x 8 x 12.



Assali

6 assi. Assali 1 e 2 con trasmissione convenzionale, assali 4 e 5 con MegaDrive™.



Sospensioni

MEGATRAK®. Tutte le ruote sono montate su sospensioni idropneumatiche indipendenti con bloccaggio idraulico. Controllo del livellamento longitudinale e trasversale con livellamento automatico per la circolazione stradale.

Corsa +170mm/-130mm. Controllo del livellamento delle sospensioni anche tramite i pannelli laterali di comando degli stabilizzatori.



Pneumatici

12 pneumatici montati in singolo 385/95 R25 (14.00 R25).



Sterzo

Doppio circuito, Servoassistito idraulicamente con pompa di emergenza. Assi 1 2 5 e 6 comandati dallo sterzo durante la marcia. Comando separato Sterzata idraulica (steer by wire) gestita elettronicamente per assi dal 3 al 6 per eseguire la sterzata combinata e a granchio.



Freni

Freno di servizio: pneumatico a doppio circuito, agente su tutte le ruote, con essiccatore dell'aria. Freno motore, ABS. Freno di parcheggio: con molle precaricate a comando pneumatico agente sugli assi 2,4, 5 e 6.



Cabina

Design composito in alluminio e plastica rinforzata con fibre di vetro. Due posti, sedili totalmente regolabili e con sospensione pneumatica, cinture di sicurezza. Cristalli di sicurezza, impianto di riscaldamento, specchietti laterali riscaldati, tachigrafo, contachilometri, strumentazione completa per tutte le funzioni del carro. Stereo radio/CD player, estintore da 5 Kg montato in cabina, Aria condizionata, 2 luci stroboscopiche di serie. Attacco 12V in cabina. Videocamera per la manovra in retromarcia.



Impianto elettrico

Alternatore trifase 28V/100 A, due batterie 12V 170Ah. Luci e segnali a 24 V.

* Accessori opzionali

- Ruote da 445/95 R25 (cerchione 16.00 R25).
- Ruote da 525/80 R25 (cerchione 20.5 R25).
- Retarder idraulico integrato nella trasmissione.
- Cerchioni in alluminio.
- Cuccetta ribaltabile in cabina guida.
- Riscaldatore diesel della cabina indipendente dal motore che funge anche da preriscaldatore del motore.
- Valvole di disinserimento del motore.
- Motore Tier 3 : Mercedes-Benz OM 502 LA, 450 kW (612 PS) a 1800 r.p.m. Coppia massima : 2700 Nm a 1300 r.p.m.

* Altri a richiesta.

Крановая установка

Стрела

Пяти-секционная стрела TWIN-LOCK™ 15,4 - 60,0 м.
Максимальная высота оголовка стрелы 63,0 м.

Подъем стрелы

1 цилиндр с предохранительным клапаном, угол подъема от -1,5° до +82°.

Ограничитель грузовой момент и устройство для отключения подъема в крайнем верхнем положении.

Ограничитель грузовой момент и ограничитель высоты подъема крюка с звуковой и визуальной сигнализацией и блокировкой органов управления. Эти системы выводят на дисплей угол наклона стрелы, длину, радиус, высоту оголовка стрелы, относительный грузовой момент, максимально допустимую нагрузку, текущую нагрузку и предупреждение о возможности перегруза, которое повлечет за собой блокировку управления краном.

Кабина

Кабина: **Алюминиевая**, с круговым обзором, наклоняемая (примерно 20°), безосколочное стекло, регулируемое место оператора с подвеской, устройство для обогрева водой с подогревом от двигателя. Органы управления краном встроены в подлокотник. Эргономичная приборная панель и система управления краном. Кондиционирование воздуха.

Поворот

3 поворотных механизма с аксиально-поршневыми гидравлическими двигателями, планетарной передачей.

Противовес

135 тонн, состоящий из различных секций. Гидравлическая система монтажа противовесов.

Гидравлическая система

5 отдельных контура, 3 аксиально-поршневой насос с переменным рабочим объемом, с электронным ограничителем мощности и 2 насосом со сдвоенной зубчатой передачей для поворота крана. Охладитель масла, регулируемый с помощью термореле. Емкость бака: 1300 л.

Система управления

Полностью электронная система управления движением крана с электрорычагами управления и с автоматическим возвратом в нейтральное положение. Эта система соединена с локальным интерфейсом управления и системой управления работой двигателя при помощи шины CAN-BUS. Система ECOS снабжена графическим дисплеем. CRANE STAR Telematic system.

Лебедка основного подъема

Аксиально-поршневой гидромотор с планетарной передачей и тормозом. Индикатор вращения барабана. Камера лебедки и освещение.

* Дополнительное оборудование (по выбору)

- Автоматическое подключение MegaWingLift.
- Стрела 3,5 м и 7,5 м для тяжелых режимов работы.
- Решетчатая вставка для удлинения стрелы, 12-64 м, с секциями по 6 и 12 м.
- Подъемная стрела, 25-79 м, с секциями по 6 и 12 м.
- вспомогательная лебедка, автоматическая с противовесом.
- Камера оголовка стрелы.
- Комплект для демонтажа стрелы.

Тягач

Шасси

Специальное 6-осное шасси: цельносварное, устойчивое к кручению, коробчатого типа, выполненное из высокопрочной стали.

Выносные опоры

4 двойные балки с гидравлическим способом телескопирования с вертикальными цилиндрами и основаниями выносных опор. Независимый контроль горизонтального и вертикального передвижения с каждой стороны тягача и из кабины оператора. Электронный индикатор уровня с автоматической системой выравнивания. Рабочее освещение каждой выносной опоры. Индикатор нагрузки на подушку выносной опоры со считыванием данных на крановой установке и ходовой части.

Двигатель

Mercedes-Benz OM502LA, дизельный, 6-цилиндровый, с водяным охлаждением, с турбоагрегатом, 405 кВт (551 л.с.) при 1800 об/мин. (80/1269 EWG - сменный вентилятор). Макс. крутящий момент: 2600 Нм при 1300 об/мин. Емкость топливного бака: 300 + 350 л. Выбросы двигателя: EUROMOT / EPA / CARB Tier 4i (не дорожный).

Трансмиссия

ZF AS Tronic 12, электронное автоматическое переключение трансмиссии.

Ведущие / Управляемые оси

12 x 8 x 12.

Оси

6-осное исполнение. Оси 1 и 2 с традиционным приводом, оси 4 и 5 с MegaDrive™.

Подвеска

MEGATRAK*. Подвеска всех колес гидропневматическая с гидравлической блокировкой. Контроль продольного и поперечного уровня с автоматической системой выравнивания на дороге. Диапазон +170 мм/-130 мм. Контроль активной подвески на блоках управления стрелой.

Шины

12 шин, 385/95 R25 (14.00 R25).

Рулевое управление

Двухконтурная гидравлическая схема управления поворотами с аварийным насосом системы управления. Оси 1, 2, 5 и 6 управляют движением по дороге (управление при помощи электроники). Раздельное электронное гидравлическое управление 3, 4, 5 и 6 осями для всех управляемых колес.

Тормоза

Рабочая тормозная система: пневматическая двухконтурная, с работой на все колеса, осушитель воздуха. Стояночный тормоз: пневматически управляемый пружинный тормоз на 2, 4, 5 и 6 осях.

Кабина

Композитный алюминий и упрочненная волоконная пластмасса. на 2 человека, безосколочное стекло, водительское место с пневматической подвеской, независимое от двигателя устройство подогрева горячей водой. Органы отображения информации и управления краном. Система обратной камеры. Кондиционирование воздуха. Разъем 12 В. Два проблесковых маяка.

Электросистема

Трехфазный генератор переменного тока 28 В/100А, 2 батареи 12 В/170 А-ч. Система освещения и сигнализации 24 В.

* Дополнительное оборудование (по выбору)

- 12 шин, 445/95 R25 (16.00 R25).
- 12 шин, 525/80 R25 (20.5 R25) - Ширина транспортного средства 3,10 м.
- Гидравлический замедлитель, интегрированный в коробку передач.
- Алюминиевые обода.
- спальное место в кабине.
- Независимое от двигателя устройство для обогрева горячей водой с предварительным нагревом от двигателя.
- Клапаны останова двигателя.
- Двигатель, соответствующий Tier 3: Mercedes-Benz OM 502 LA, 450 кВт (612 л.с.) при 1800 об/мин. Макс. Крутящий момент: 2700 нм при 1300 об/мин.

Load charts • Traglasten • Capacités de levage Capacidades • Capacità • Таблицы грузоподъемности

Notes • Hinweise • Notes • Notas • Note • Примечания

The lifting capacities correspond to EN 13000:2010.

The lifting capacities likewise fulfil the requirements of ISO 4305 and DIN 15019, Part 2, with regard to stability, and DIN 15018, Part 3, and FEM 5004 with regard to strength.

The lifting capacities are given in tonnes.

Lifting capacity = Payload + weight of hook block and suspending device.

The lifting capacities for the main boom only apply with the jib dismantled.

Lifting capacities > 237 t require additional equipment.

Lifting capacities > 259 t require special equipment.

The right is reserved to modify the load-carrying capacities.

Note: The details in this brochure serve only as general information. The determinant values for the operation of the crane are the lifting capacity tables belonging to it and the operating instructions.

Lifting capacities are indicated by boom length for different levels of extension. The actual boom length will be in accordance with the selected configuration for boom extension.

Die Tragfähigkeiten entsprechen EN 13000:2010.

Die Tragfähigkeitswerte erfüllen ebenfalls die Anforderungen von ISO 4305 und DIN 15019 Teil 2 bezüglich Standsicherheit sowie von DIN 15018 Teil 3 und FEM 5004 bezüglich Festigkeit.

Die Tragfähigkeitswerte sind in Tonnen angegeben.

Tragfähigkeit = Nutzlast + Gewicht der Hakenflasche und Anschlagmittel.

Die Tragfähigkeitswerte für den Hauptausleger gelten nur bei demontierten Spitzenauslegern.

Die Tragfähigkeitswerte > 237 t erfordern eine Zusatzausrüstung.

Die Tragfähigkeitswerte > 259 t erfordern eine Sonderausrüstung.

Änderung der Tragfähigkeiten vorbehalten.

Anmerkung: Die Daten dieser Broschüre dienen nur zur allgemeinen Information. Maßgebend für den Betrieb des Kranes sind die zugehörigen Tragfähigkeitstabellen und die Bedienungsanleitung.

Die Traglastwerte sind aus unterschiedlichen Teleskopierungen pro Auslegerlänge zusammengefasst. Die tatsächliche Auslegerlänge kann variieren.

Les capacités de levage sont conformes à la norme EN 13000:2010.

Les capacités de levage respectent également les exigences des normes ISO 4305 et DIN 15019, paragraphe 2, relatives à la stabilité, ainsi que celles des normes DIN 15018 paragraphe 3 et FEM 5004 relatives à la résistance.

Les capacités de levage sont exprimées en tonnes.

Capacité = charge utile + poids du crochet et du dispositif d'élingage.

Les capacités de levage de la flèche principale ne sont valables que lorsque la fléchette est démontée.

Des capacités de levage > 237 tonnes exigent l'utilisation d'un dispositif supplémentaire.

Des capacités de levage > 259 tonnes exigent l'utilisation d'un dispositif spécial.

Le constructeur se réserve le droit d'apporter des modifications à ces capacités de levage.

Remarque : Les données de cette brochure ne sont fournies qu'à titre d'information générale. La manipulation de la grue nécessite l'étude des tableaux de capacité et la lecture des guides d'utilisation correspondants.

Les capacités de levage sont données par longueur de flèche pour différents niveaux de télescopage. Les longueurs de flèche réelles peuvent varier.

Las capacidades de carga corresponden a EN 13000:2010.

Asimismo los valores de carga cumplen las disposiciones de las normas ISO 4305 y DIN 15019, 2.ª parte, respecto a la estabilidad, y DIN 15018, 3.ª parte, y FEM 5004 respecto a la fuerza.

Los valores de carga se dan en toneladas.

Capacidad de carga = Carga + peso de la garrucha del gancho y del mecanismo de elevación.

Los valores de carga para la pluma principal sólo son válidos cuando no hay plumines instalados.

Valores de carga > 237 t requieren un mecanismo de elevación suplementario.

Valores de carga > 259 t requieren una unidad especial.

Se reserva el derecho a modificar las capacidades de carga.

Nota: Los detalles contenidos en este folleto sirven sólo como información general. Los valores determinantes para el funcionamiento de la grúa son los cuadros de cargas correspondientes, así como las instrucciones de funcionamiento.

Las capacidades de carga se indican por longitud de pluma para los diferentes niveles de despliegue. Las longitudes reales de la pluma pueden variar.

Le tabelle di portata sono conformi alla norma EN 13000:2010.

I valori delle tabelle di portata sono conformi anche ai requisiti delle norme ISO 4305 e DIN 15019, Parte 2, per quanto riguarda la stabilità, ed alle norme DIN 15018, Parte 3, e FEM 5004 per quanto riguarda il calcolo di resistenza della struttura.

I valori di portata sono indicati in tonnellate.

Capacità di portata = carico utile + peso del gancio e accessori di sollevamento.

I valori delle tabelle di portata per il braccio principale si applicano solo con i falconi smontati.

Valori di portata > 237 t richiedono un equipaggiamento supplementare.

Valori di portata > 259 t richiedono un equipaggiamento speciale.

Si riserva il diritto di modificare i valori di portata.

Nota: i dettagli forniti nel presente opuscolo servono solo come informazioni di carattere generale. I valori determinanti per il funzionamento della gru sono le tabelle di portata appartenenti alla gru stessa e le istruzioni di funzionamento.

Le capacità di sollevamento sono fornite per lunghezza del braccio per i diversi livelli di estensione. Le lunghezze del braccio reali possono variare.

Грузоподъемность соответствует EN 13000:2010.

Кроме того, грузоподъемность удовлетворяет требованиям ISO 4305 и DIN 15019 (часть 2) в отношении устойчивости, и DIN 15018, (часть 3), и FEM 5004 в отношении прочности материала.

Грузоподъемность приведена в тоннах.

Грузоподъемность = Полезный груз + вес крюкового блока и устройства для подвешивания.

Грузоподъемность основной стрелы только при сложенном удлинителе.

Грузоподъемность > 237 т необходимо дополнительное оборудование.

Грузоподъемность > 259 т необходимо специальное оборудование.































Оставляем за собой право изменять грузоподъемность.

Примечание: В данной брошюре приведена только общая информация. Рабочие значения для крана приведены в таблицах грузоподъемности (см. данную брошюру и инструкции по эксплуатации).

Грузоподъемность приведена по длине стрелы для различных уровней телескопирования. Действительная длина стрелы может варьироваться

Notes • Hinweise • Notes • Notas • Note • Примечания

Symbols • Symbolerklärung • Glossaire des symboles • Glosario de simbolos • Glossario dei simboli • Символы

	Axles Achsen Ponts Ejes Assali Оси		Crane functions Kranbewegungen Mouvements de la grue Funciones de la grúa Funzioni della gru Функции крана		Hookblock / Capacity Hakenflasche / Traglast Moufle / Force de levage Gancho / Capacidad Gancio / Capacità Крюковой блок / Грузоподъемность		Speed Geschwindigkeit Vitesse Velocidad Velocità Скорость
	Axle load Achslast Charge à l'essieu Carga por eje Carico sugli assi Нагрузка на ось		Crane travel Fahrstellung Déplacement de la grue Grúa en traslado Traslazione gru Перемещение крана		Hydraulic system Hydrauliksystem Circuit hydraulique Sistema hidráulico Impianto idraulico Гидравлическая система		Suspension Federung Suspension Suspensión Sospensioni Подвеска
	Boom Ausleger Flèche Pluma Braccio Стрела		Drive/Steer Antrieb/Lenkung Direction/Déplacement Tracción/Dirección Trazione/Sterzo Ведущие/Управляемые оси		Lattice extension Gitterspitze Extension treillis Extensión de celosía Falcone tralicciato Гусек		Transmission / Gear Getriebe / Gang Boîte de vitesses / Rapport Transmisión / Cambio Trasmissione / Cambio Трансмиссия / передача
	Boom elevation Wippwerk Relevage Elevacion de pluma Elevazione braccio Подъем стрелы		Electrical system Elektrische Anlage Circuit électrique Sistema eléctrico Impianto elettrico Электросистема		Lattice extension (luffing) Gitterspitze (wippbar) Extension treillis (volée variable) Extensión de celosía (angulable hidráulicamente) Falcone tralicciato (inclinabile) Гусек (с изменением вылета)		Travel speed Fahrtgeschwindigkeit Vitesse de déplacement Velocidad de desplazamiento Velocità di traslazione Скорость движения
	Boom telescoping Teleskopieren Télescopeage de flèche Telescopaje de pluma Lunghezza braccio Выдвижение стрелы		Engine Motor Moteur Motor Motore Двигатель		Luffing Jib Wippspitzenausleger Volée variable Plumín angulable Falcone a volata variabile Маневровый гусек		Tyres Bereifung Pneumáticos Neumáticos Pneumatici Шины
	Brakes Bremsen Freins Frenos Freni Тормоза		Free on wheels Freistehend Sur pneus Sobre neumáticos Su gomme Свободные внутренние колеса		Low range Kriechgang Gamme basse Marchas cortas Fuoristrada Низкий диапазон		
	Cab Kabine Cabine Cabina Cabina Кабина		Gradeability Steigfähigkeit Aptitude en pente Superacion de pendientes Pendenza superabile Преодолеваемый уклон		Outriggers Abstützung Calage Estabilizadores Stabilizzatori Выносные опоры		
	Carrier frame Chassis-Rahmen Châssis porteur Bastidor Telaio Рама тягача		Main hoist Haupthubwerk Treuil principal Cabrestante principal Argano principale Лебедка основного подъема		Radius Ausladung Portée Radio Raggio Вылет		
	Counterweight Gegengewicht Contrepoids Contrapeso Contrappeso Противовес		Auxiliary hoist Hilfshubwerk Treuil auxiliaire Cabrestante auxiliar Argano secondario Лебедка вспомогательного подъема		Slewing/Working range Drehwerk/Arbeitsbereich Orientation/Rayon d'opération Giro/Gama de trabajo Rotazione/Area di lavoro Поворот/ Рабочий диапазон		

Manitowoc Cranes

Regional headquarters

Manitowoc - Americas

Manitowoc, Wisconsin, USA

Tel: +1 920 684 6621

Fax: +1 920 683 6277

Shady Grove, Pennsylvania, USA

Tel: +1 717 597 8121

Fax: +1 717 597 4062

Manitowoc - Europe, Middle East, Africa

Ecully, France

Tel: +33 (0)4 72 18 20 20

Fax: +33 (0)4 72 18 20 00

China

Shanghai, China

Tel: +86 21 6457 0066

Fax: +86 21 6457 4955

Greater Asia-Pacific

Singapore

Tel: +65 6264 1188

Fax: +65 6862 4040

Regional offices

Americas

Brazil

Alphaville

Mexico

Monterrey

Chile

Santiago

Europe, Middle East, Africa

Czech Republic

Netvorice

France

Baudemont

Cergy

Decines

Germany

Langenfeld

Hungary

Budapest

Italy

Lainate

Netherlands

Breda

Poland

Warsaw

Portugal

Baltar

Russia

Moscow

U.A.E.

Dubai

U.K.

Buckingham

China

Beijing

Chengdu

Guangzhou

Xian

Greater Asia - Pacific

Australia

Brisbane

Melbourne

Sydney

India

Chennai

Delhi

Hyderabad

Pune

Korea

Seoul

Philippines

Makati City

Singapore

Factories

Brazil

Passo Fundo

China

TaiAn

Zhangjiagang

France

Charlieu

Moulins

Germany

Wilhelmshaven

India

Pune

Italy

Niella Tanaro

Portugal

Baltar

Fânzeres

Slovakia

Saris

U.S.A.

Manitowoc

Port Washington

Shady Grove

This document is non-contractual. Constant improvement and engineering progress make it necessary that we reserve the right to make specification, equipment, and price changes without notice. Illustrations shown may include optional equipment and accessories and may not include all standard equipment.

Die Angaben in diesem Dokument erfolgen ohne Gewähr. Wir verbessern unsere Produkte ständig und integrieren den technischen Fortschritt. Aus diesem Grund behalten wir uns das Recht vor, die technischen Daten, die Ausstattungsdetails und die Preise unserer Maschinen ohne Vorankündigung zu ändern.

Ce document est non-contractuel. Du fait de sa politique d'amélioration constante de ses produits liée au progrès technique, la Société se réserve le droit de procéder sans préavis à des changements de spécifications, d'équipement ou de prix. Les illustrations peuvent comporter des équipements ou accessoires optionnels ou ne pas comporter des équipements standards.

Este documento no es contractual. El perfeccionamiento constante y el avance tecnológico hacen necesario que la empresa se reserve el derecho de efectuar cambios en las especificaciones, equipo y precios sin previo aviso. En las ilustraciones se puede incluir equipo y accesorios opcionales y es posible que no se muestre el equipo normal.

Documento non contrattuale. In considerazione della sua politica di costante miglioramento dei prodotti connesso al progresso tecnico, la Società si riserva il diritto di modificare senza preavviso specifiche, equipaggiamenti o prezzi. Le illustrazioni possono contenere equipaggiamenti o accessori optional o non contenere equipaggiamenti standard.

Данный документ не является контрактным. Принимая во внимание необходимость постоянного совершенствования и модернизации мы оставляем за собой право изменять спецификации, конструкции и стоимость без предварительного уведомления. Приведенные иллюстрации могут содержать дополнительные компоненты и принадлежности, не входящие в стандартный комплект поставки оборудования.